



2017 ACCESSORIES



V7 II RANGE	18
V7 III STONE	48
V7 III SPECIAL	68
V7 III RACER	86
V7 50 ANNIVERSARIO	88
V9 BOBBER	90
V9 ROAMER	106
MGX-21	120
AUDACE CARBON	132
ELDORADO	146
CALIFORNIA 1400 TOURING	166
APPAREL	184



MOTO GUZZI®



ONCE UPON A TIME, THE FUTURE

Ci sono marche che sono da **sempre in anticipo**. Ci sono **storie** che per essere nuove basta che si guardino alle spalle. Ci sono vite che diventano **eterno** perché sono state vissute. E solo chi ha scelto una Moto Guzzi vive il **futuro** in eterno.

.....
*Some brands have **always been ahead of their time**. Some **stories** simply have to look back to be new. Some lives become **eternal** because they have been lived. And only people who choose a Moto Guzzi bike live an **eternal future**.*



MOTO GUZZI®



START FAST

Il **mito** non nasce, prende subito il volo.
La **storia** non si aspetta. Come il futuro, si costruisce.
È dall'inizio, che i comportamenti segnano la **strada**.
Moto Guzzi nasce nel 1921.
È dall'inizio di questa storia che si crea l'**icona**.

.....
*Legends aren't born, they grow up instantly.
History is not something you wait for.
Like the future, you build it.
You set your **path**, right from the start.
The Moto Guzzi company was established in 1921.
And the **icon** was created when its story began.*

..... 1921
MODELLO "NORMALE"
"NORMALE" MODEL

FIGHT FOR LEGEND

Soprattutto i **predestinati** devono lavorare duro. Perché le **competizioni** producono evoluzione solo se le vinci. Perché le **vittorie** costruiscono autostima solo se tagli il traguardo davanti. Perché il secondo è **il primo** ad essere dimenticato.

.....
*Life is tough for the **predestined**. Because **competitions** drive evolution only if you win them. Because **victories** build self-esteem only if you are first over the finishing line. Because the runner-up is **the first** to be forgotten.*



MOTO GUZZI®





POWER TO CHANGE

È il movimento che genera l'**eccellenza**.
È la capacità di modificarsi che accelera la **superiorità**.
È l'**evoluzione** che modifica gli standard.

*Movement is what generates **excellence**.
A capacity for change is what drives **superiority**.
Evolution is what changes standards.*



MODELLO/MODEL
NORMALE
ANNO/YEAR
1921



MODELLO/MODEL
C4V
ANNO/YEAR
1924



MODELLO/MODEL
BICILINDRICA 500 CC
ANNO/YEAR
1935



MODELLO/MODEL
GTV
ANNO/YEAR
1945



MODELLO/MODEL
DONDOLINO 500 CC
ANNO/YEAR
1945



MODELLO/MODEL
SUPERALCE
ANNO/YEAR
1945



MODELLO/MODEL
MOTOLEGGERA 65
ANNO/YEAR
1946



MODELLO/MODEL
AIRONE
ANNO/YEAR
1946



MODELLO/MODEL
FALCONE SPORT
ANNO/YEAR
1950



MODELLO/MODEL
GALLETTO
ANNO/YEAR
1950 - 1966



MODELLO/MODEL
LODOLA GT
ANNO/YEAR
1956



MODELLO/MODEL
OTTO CILINDRI GARA
ANNO/YEAR
1957



MODELLO/MODEL
ZIGOLO 110 CC
ANNO/YEAR
1960



MODELLO/MODEL
NUOVO FALCONE MILITARE
ANNO/YEAR
1968



MODELLO/MODEL
STORNELLO 125 SPORT
ANNO/YEAR
1960



MODELLO/MODEL
V7 AMBASSADOR
ANNO/YEAR
1969



MODELLO/MODEL
V7 SPECIAL
ANNO/YEAR
1969



MODELLO/MODEL
V7 SPORT
ANNO/YEAR
1971



MODELLO/MODEL
V850 GT
ANNO/YEAR
1972 - 1974



MOTO GUZZI®

EXPRESS YOUR SOUL

Lascia il **segno** e non voltarti mai.
Perché il **traguardo** più bello lo devi ancora tagliare.
Perché il **riconoscimento** più significativo
deve ancora venire.

.....
*Leave your **mark** and never look back. Because the best
finishing line still lies ahead. Because the most significant
recognition is yet to come.*





PROUD TO SHARE

È il gruppo che vince. Sono i rapporti di amicizia che costruiscono la forza di **una comunità**. Indossare la stessa divisa. Vedere il mondo con la stessa ottica. Provare lo stesso brivido.

Tre passi per condividere la **passione**. E i guzzisti sanno come: con un **clan** per unire le esperienze, raccontarsi storie, diventare parte di un universo più grande.

theclan.motoguzzi.com

.....
*The group is the secret of success. Strong communities are built on ties of friendship. Wear the same uniform. See the world through the same lens. Experience the same thrill. Three steps to live the same **passion**. Guzzi bikers know how: as part of a **clan** where they can share experiences, tell stories, be part of a larger universe.*
theclan.motoguzzi.com

BORN TO CUSTOMISE

Un accessorio Moto Guzzi è originale solo se è **pensato, disegnato, ingegnerizzato** dalla stessa mano che ha dato a queste moto un **dna** unico e riconoscibile.
Un accessorio Moto Guzzi è originale solo se garantisce a queste moto di continuare ad essere **protette, tutelate, assistite**.
Un accessorio Moto Guzzi è originale solo se fa diventare la tua moto così **personale** da sentirti anche tu parte della **leggenda**. Ma se è così, è poco definirlo accessorio.
È per il tuo **“Originale Moto Guzzi”** che riconosceranno la tua passione. E rispetteranno la tua moto.

*A Moto Guzzi accessory is original only if it is **conceived, designed and engineered** by the same people who gave these motorbikes their unique **DNA**.
A Moto Guzzi accessory is original only if it ensures that these bikes will continue to be **protected, safeguarded, assisted**.
A Moto Guzzi accessory is original only if it makes your motorbike so **personal** you feel you're part of the **legend** too. But in that case, calling it an accessory hardly describes its role. Thanks to your **“Moto Guzzi Original”**, people will recognise your passion. And respect your motorbike.*



MOTO GUZZI®

V7 II

RANGE

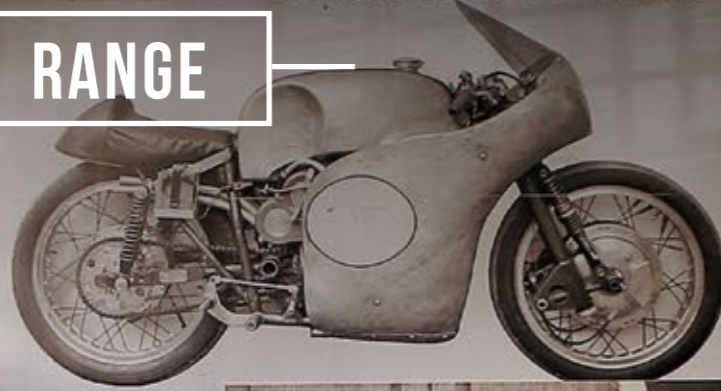

MOTO GUZZI®



**PARABREZZA
WINDSHIELD**

.....
COD. 8877724

Studiato appositamente per offrire la massima protezione aerodinamica senza tralasciare l'attenzione al design. Omologato secondo i più severi standards DOT e TUV e testato in ogni condizione.

Designed specifically to offer the maximum aerodynamic protection without neglecting the attention for the design. Approved according the most severe DOT and TUV standards and tested in all conditions.



**CUPOLINO
TOP FAIRING**

.....
COD. 886995

Il kit comprende il cupolino in materiale plastico stampato (al grezzo) e i supporti in alluminio con relativa viteria.

The kit includes a plastic moulded top fairing (unfinished) and the aluminium brackets with relative nuts and bolts.

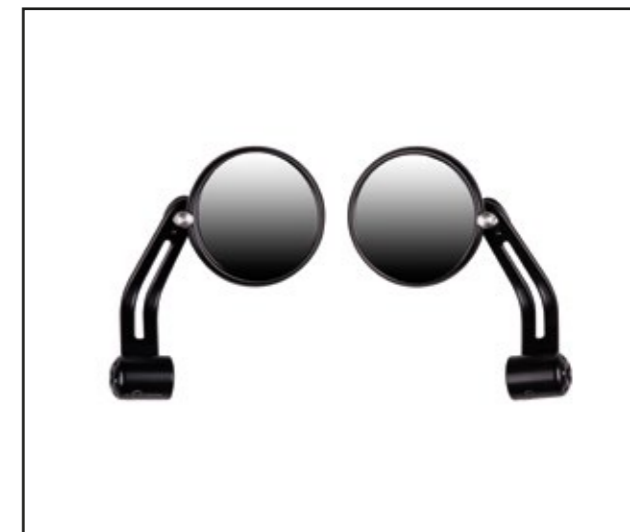

**KIT SPECCHI MANUBRIO NERI
BLACK HANDLEBAR MIRRORS**

.....
COD. 25000610

Omologati ECE, in alluminio anodizzato nero, con snodi lenticolari e viti in acciaio inox. Si fissano al manubrio lasciando la parte riflettente nella stessa posizione di quelli di serie.

ECE approved, in black painted aluminium, with lenticular ball joints and stainless steel screws. They are fixed to the handlebar, leaving the reflective part in the same position as the factory mirrors.



**KIT SPECCHI MANUBRIO CROMATI
CHROMED HANDLEBAR MIRRORS**

.....
COD. 25000611

Omologati ECE, in alluminio lucidato, con snodi lenticolari e viti in acciaio inox. Si fissano al manubrio lasciando la parte riflettente nella stessa posizione di quelli di serie.

ECE approved, in chromed aluminium, with lenticular ball joints and stainless steel screws. They are fixed to the handlebar leaving the reflective part in the same position as the factory mirrors.

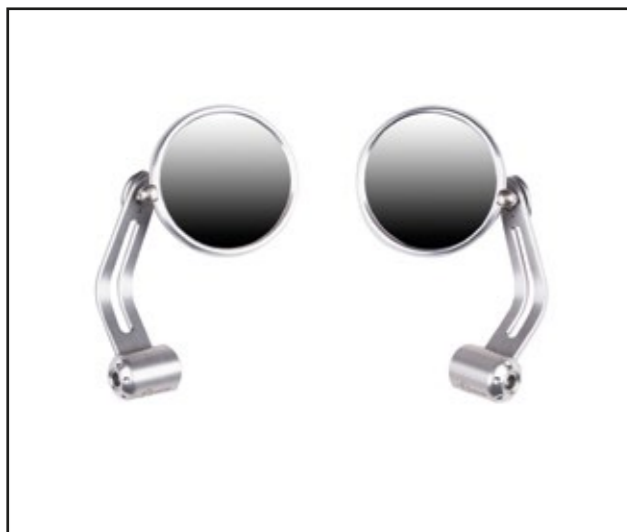

**SPECCHI MANUBRIO
HANDLEBAR MIRRORS**

.....
COD. 2S000261

Specchietti da manubrio, sostituiscono quelli di serie. Omologati ECE, in alluminio, con snodi lenticolari e viti in acciaio inox. Si fissano al manubrio e fanno anche da paramani, lasciando la parte riflettente nella stessa posizione di quelli di serie.

Handlebar mirrors that replace the factory mirrors. ECE approved, in aluminium, with lenticular ball joints and stainless steel screws. They are fixed to the handlebar and also function as handguards, leaving the reflective part in the same position as the factory mirrors.



**COVER STRUMENTI
IN ALLUMINIO SATINATO
SATIN-FINISHED ALUMINIUM
TOOLS COVER**

.....
COD. 606181M

Mostrina in alluminio satinato a mano, sostituisce la parte di produzione verniciata nera. Solo per V7 II.

Hand satin-finished aluminium panel, replacing the black painted production part. Only for V7 II.



**MANUBRIO CROMATO
CHROMED HANDLEBAR**

.....
COD. 2S000174

Manubrio cromato, per una personalizzazione esclusiva della propria V7.

Chromed handlebar for an exclusive V7 customising.



**SEMIMANUBRI CROMATI
CHROMED SEMI-HANDLEBAR**

.....
COD. 2S000176

Kit di semimanubri cromati, completo di cavi e tubi per versione ABS, per cambiare l'impostazione della tua V7 in qualcosa di ancora più sportivo.

Kit of chromed semi-handlebars, complete with cables and tubes for ABS version, to change the setting of your V7 into something even more sporty.



GUZZI MULTIMEDIA PLATFORM

.....
COD. 606408M
COD. 2S000170 kit installazione / installation kit

GMP è il nuovo dispositivo che consente di collegare il proprio Smartphone alla moto, trasformandola in una vera e propria piattaforma multimediale. Per l'installazione utilizzare il supporto dedicato 2S000170.

GMP is the new device that allows you to connect your smartphone to the motorcycle, turning it to a real multimedia platform. To mount it, use the dedicated bracket 2S000170.



**KIT SUPPORTO USB
USB SOCKET KIT**

.....
COD. 2S000166

Presca USB fornita di supporto dedicato per installazione nel sottosella, per la ricarica dei supporti elettronici, non consente il dialogo con gli apparati elettronici del mezzo.

USB socket with bracket for installation under the saddle, to recharge the electronic media, does not allow dialogue with the electronic devices of the vehicle.



**KIT COPERCHIO INIETTORI
INJECTOR COVERS KIT**

.....
COD. 606436M

La coppia di coperchi iniettori permette di proteggere questi ultimi dal contatto accidentale con le ginocchia del guidatore.

The injector covers protects them against accidental contact with the driver's knees.



**FIANCATINE IN ALLUMINIO
ALUMINIUM SIDE FAIRINGS**

.....
COD. 886994

Le fiancatine in alluminio spazzolato e anodizzato rendono V7 ancora più bella: ne snelliscono i fianchi e richiamano le creazioni artigianali tipiche delle gare per derivate di serie degli anni 70.

The brushed and anodized aluminium fairings make your V7 even more attractive: they slim down the sides and are reminiscent of the hand crafted creations which were typical of factory derivative series in the 70's.

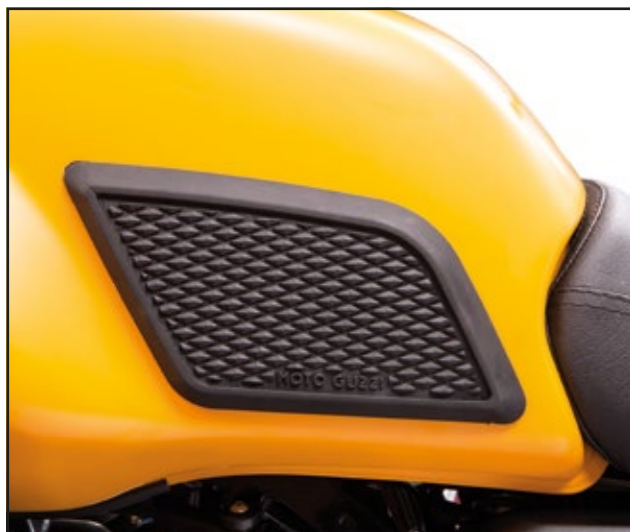

**PROTEZIONI SERBATOIO
TANK PROTECTION**

.....
COD. 897021

Coppia di paraginocchia adesivi in morbida gomma da applicare ai lati del serbatoio, caratterizzati da un disegno a rombi e impreziositi dal logo Moto Guzzi.

Adhesive soft rubber knee pads to be applied on the tank sides, with rhombus design and enriched with the Moto Guzzi logo.



**COPRISERBATOIO CON BORSELLO
TANK COVER WITH POCKET**

.....
COD. B063837

Realizzato in pelle con trattamento antiacqua, offre una comoda tasca portaoggetti e portadocumenti poco ingombrante.

Made of leather with waterproof treatment, it offers a convenient object holder pocket and small document carrier.



**BORSA CON COPRISERBATOIO
TANKBAG WITH TANK COVER**

.....
COD. B063838

Borsa serbatoio in nylon e vera pelle idrorepellente, dotata di 2 tasche laterali e una superiore portacartina. Si fissa tramite agganci rapidi al copriserbatoio, che può restare montato sul serbatoio grazie al foro per il rifornimento ed è facilmente sganciabile e trasportabile grazie alla pratica maniglia.

Waterproof tank bag in nylon and leather, equipped with 2 side pockets and a top map holder. The bag connects through fast clips to the tank cover that can stay mounted on the tank thanks to the refuelling hole, being easily detachable and carried using the practical handle.



**SELLA COMFORT GEL
COMFORT GEL SADDLE**

.....
COD. B063597

Sella biposto con inserti in gel nelle zone pilota e passeggero. Oltre al comfort, offre un maggior appoggio a terra grazie al diverso disegno dello schiumato. Logo "Comfort Gel" punzonato.

Two seat saddle with gel inserts in the driver and passenger area. Besides comfort, it offers better contact with ground due to the different design of the foamed structure. Punched "Comfort Gel" logo.





**SELLA RIBASSATA COMFORT GEL
LOWER COMFORT GEL SADDLE**

.....
COD. B063598

Biposto, unisce il comfort del gel alla comodità del profilo rivisto e ribassato, per consentire al pilota un migliore e più sicuro appoggio a terra. Logo "Comfort Gel" punzonato.

Two-seated, combines the comfort given by the gel with the revised and lowered profile, to allow the driver to have a better and safer contact with the ground. Punched "Comfort Gel" logo.



**KIT BIPOSTO
TWO-SEATER KIT**

.....
COD. 886870

Il kit è composto dalla sella biposto di serie sulla versione Stone/Special ma in una versione specifica con diverso rivestimento e cuciture, dalle pedane passeggero complete e dalle maniglie.

The kit consists of the two-seats factory saddle on the Stone/Special version, but in a specific version with different finishing and stitching, complete passenger footpegs and handles.



**KIT BUSSOLE FORATE
DRILLED BUSHING KIT**

.....
COD. 25000172

Tre bussole forate, per migliorare l'estetica della V7, si applicano in corrispondenza degli attacchi degli ammortizzatori.

Three drilled bushings to improve the look of the V7, applied in correspondence with the shock absorber fittings.



**AMMORTIZZATORI PERFORMANCE
PERFORMANCE SHOCK ABSORBER**

.....
COD. 897773 NERO/BLACK
COD. 606091M ROSSO/RED

Con serbatoio gas separato, regolabili in estensione, compressione e precarico, migliorano comfort e guidabilità grazie alle eccezionali caratteristiche tecniche che li contraddistinguono.

With Piggy Back chamber, adjustable in extension, compression and preload, improved comfort and handling thanks to exceptional technical features that distinguish them.



**PEDANE PILOTA IN ALLUMINIO
PILOT ALUMINIUM FOOTPEGS**

.....
COD. 25000168

Pedane anteriori in alluminio, alleggerite e dalla linea sportiva, accentuano lo spirito racing della V7.

Front aluminium footpegs, add lightness and sportive line, they highlight the racing spirit of the V7.



**PEDANE PASSEGGERO IN ALLUMINIO
PASSENGER ALUMINIUM FOOTPEGS**

.....
COD. 25000169

Pedane posteriori in alluminio, alleggerite e dalla linea sportiva, accentuano lo spirito racing della V7.

Rear aluminium footpegs, add lightness and sportive line, they highlight the racing spirit of the V7.



**PORTAPACCHI
REAR RACK**

.....
COD. 983163

Realizzato in acciaio cromato, si fissa al posto delle maniglie passeggero, che sostituisce grazie all'ampio maniglione integrato.

Made of chromed steel, it is mounted in place of the passenger handle that it replaces thanks to the large integrated handle.



**BORSE LATERALI
SIDE BAGS**

.....
COD. 983162

Kit composto dalla coppia di valigie rigide in nylon, del volume di circa 20 litri, rivestite in vera pelle idrorepellente e dotate di chiusura con fibbia in acciaio cromato, telaio di fissaggio in acciaio ad alta resistenza e coppia di borse interne asportabili in nylon. NB: solo per versione Classic.

Kit composed by a pair of Nylon rigid cases, around 20 litres capacity, covered by water-repellent coated leather, with chromed steel buckle closing system, high-resistance steel clamping frame and internal detachable nylon bags. NOTE: Only for Classic version.



**VALIGIE SEMIRIGIDE
COMPLETE DI SUPPORTI
SEMI-RIGID PANNIERS KIT
WITH BRACKETS**

.....
COD. B063096

Valigie semirigide in poliestere complete di cuffie anti-pioggia termosaldate, dotate di sistema di aggancio/sgancio rapido Fast Click. Necessitano di portapacchi.

Polyester semi-rigid bags with thermoformed rain covers, equipped with hook/quick release system Fast Click. Require luggage carriers.



**BORSA BAULETTO
REAR TOPBAG**

.....
COD. 983308

Borsa bauletto in vera pelle idrorepellente, si fissa al portapacchi dedicato tramite comode cinghie e può essere facilmente asportata grazie alla maniglia posteriore.

Water repellent top box bag made of true leather, mounted to the dedicated luggage carrier with practical straps, can be easily detached thanks to its rear handle.



**TELO COPRIMOTO "SHAPE"
"SHAPE" BIKE COVER**

.....
COD. 606028M0002

Telo su misura da interno per la protezione dalla polvere da utilizzare durante le soste in garage della moto.

È realizzato in un tessuto elasticizzato con grafica speciale.
Tailor-made motorcycle cover for inside use to protect against dust, intended for use during long periods of storing the bike in a garage. It is made of stretch fabric with special graphics.



**MANIGLIE PASSEGGERO
PASSENGER HANDGRIPS**

.....
COD. 2S000206

Supporto aggiuntivo per consentire un migliore comfort del passeggero.

Additional bracket to offer a better comfort to the passenger.



**TELO COPRIMOTO "EAGLE"
"EAGLE" BIKE COVER**

.....
COD. 606028M0001

Telo su misura da interno per la protezione dalla polvere da utilizzare durante le soste in garage della moto.

È realizzato in un tessuto elasticizzato con grafica speciale.
Tailor-made motorcycle cover for inside use to protect against dust, intended for use during long periods of storing the bike in a garage. It is made of stretch fabric with special graphics.



**TELO COPRIMOTO V7
V7 BIKE COVER**

.....
COD. 895729

Telo su misura da interno per la protezione dalla polvere da utilizzare durante le soste in garage della moto.

È realizzato in un tessuto elasticizzato con grafica speciale.
Tailor-made motorcycle cover for inside use to protect against dust, intended for use during long periods of storing the bike in a garage. It is made of stretch fabric with special graphics.



MOTO GUZZI®

Il fascino di personalizzare una Moto Guzzi V7 Stone o Special in sintonia con il proprio stile. Il Garage come ambiente di lavoro, un territorio di scambio di esperienze, una fucina di idee per gli amanti del custom. Uno spazio dove nascono modelli unici come le proprie storie.

.....
The charm of personalising a Moto Guzzi V7 Stone or Special in sync with your own style. The Garage as a work environment, an experience swapping territory, a mine of ideas for custom enthusiasts. A space where models as unique as their history are born.





**TABELLE IN ALLUMINIO LUCIDATO
POLISHED ALUMINIUM
NUMBERPLATES**

.....
COD. 2S000148

Tre tabelle portanumero, una frontale e due laterali montate su fianchetti anodizzati neri, in alluminio naturale lucidato a mano e con relativi sostegni.

Three numberplates, one front and two sides, mounted on black anodized side panels, are made in hand-polished natural aluminium, with specific supports.



**PARAFANGHI ALLUMINIO
LUCIDATO
POLISHED ALUMINIUM
MUDGUARDS**

.....
COD. 2S000147

Parafanghi in alluminio naturale lucidato a mano, a mano, danno un vantaggio in termini di peso rispetto ai componenti di serie.

Hand polished natural aluminium mudguards, give a weight advantage in comparison with original equipment.



**SERBATOIO CROMATO
CHROMED TANK**

.....
COD. 606007M

Serbatoio in metallo cromato, in abbinamento agli altri elementi in alluminio lucidato costituisce il modo migliore per dare alla tua V7 un Look "Dapper" davvero completo.

Chromed metal tank, in combination with the other elements made in polished aluminium, is the best way to give Your V7 a complete "Dapper" look.



**COPRI INIETTORI
IN ALLUMINIO LUCIDATO
POLISHED INJECTORS COVERS**

.....
COD. 2S000149

Coppia di copri iniettori in alluminio naturale lucidato a mano, variante estetica dei copri iniettori di serie, da abbinare agli altri elementi lucidati per completare il look grintoso della tua V7.

Pair of hand-polished natural aluminium injectors covers, aesthetic variant of factory injectors covers, to be combined with the other polished elements to complete the Sporty look of the V7.



**PROTEZIONI SILENZIATORE
ALLUMINIO LUCIDATO
SILENCER GUARDS**

.....
COD. 2S000150

Coppia di protezioni in alluminio naturale lucidato a mano, per scarichi di serie. Con un design più stiloso, mantengono la funzione di protezione delle gambe dal contatto con lo scarico.
Hand-polished guards set in natural aluminium, for standard exhausts. With a more stylish design, maintaining the protective function for the legs from contact with the exhaust.



**SEMIMANUBRI CROMATI
CHROMED SEMI-HANDLEBAR**

.....
COD. 2S000176

Kit di semimanubri cromati, completo di cavi e tubi per versione ABS, per cambiare l'impostazione della tua V7 in qualcosa di ancora più sportivo.
Kit of chromed semi-handlebars, complete with cables and tubes for ABS version, to change the setting of your V7 into something even more sporty



**SELLA MONOPOSTO
SINGLE-SEAT SADDLE**

.....
COD. 606124M

Sella sportiva monoposto, basata sulla linea della classica V7 Café.
Single-seat sport saddle based on the classic V7 Café line.



**SELLA MONOPOSTO PREMIUM
PREMIUM SINGLE-SEAT SADDLE**

.....
COD. 2S000260

Sella sportiva monoposto, caratterizzata da imbottiture elettrosaldate e cucite. Logo Moto Guzzi ricamato.
Single-seat sport saddle with electro-welded and stitched padding. Moto Guzzi Logo embroidered.



**SEMIMANUBRI NERI
BLACK SEMI-HANDLEBARS**

.....
COD. B063843

Kit di semimanubri completamente neri, completo di cavi e tubi, per cambiare l'impostazione della tua V7 in qualcosa di ancora più sportivo. Specifici per la versione senza ABS bicorpo.

Kit of black semi-handlebars, complete with cables and tubes to change the setting of the V7 into something even more sporty. Specifications for the version without 2-piece ABS.



**SEMIMANUBRI NERI
BLACK SEMI-HANDLEBARS**

.....
COD. 606220M

Kit di semimanubri completamente neri, completo di cavi e tubi, per cambiare l'impostazione della tua V7 in qualcosa di ancora più sportivo. Specifici per la versione senza ABS monocorpo.

Kit of black semi-handlebars, complete with cables and tubes to change the setting of the V7 into something even more sporty. Specifications for the version without mono-bloc ABS.



**AMMORTIZZATORI
PERFORMANCE NERI
BLACK PERFORMANCE
SHOCK ABSORBERS**

.....
COD. 897773
COD. 2S000281 MAGGIORATI/EXTENDED LENGHT

Con serbatoio gas separato, regolabili in estensione, compressione e precarico, migliorano comfort e guidabilità grazie alle eccezionali caratteristiche tecniche che li contraddistinguono. Molla nera.

With separate gas tank, adjustable in size, compression and preload, improved comfort and handling thanks to exceptional technical features that distinguish them.



**BORSA PORTA ATTREZZI NERA
BLACK LEATHER TOOLS BAG**

.....
COD. 605989M

Borsa portatutto in cuoio nero finito con una conca vegetale, agganciabile sul portapacchi o sul serbatoio (con l'apposita fascia dello stesso colore). La borsa è resistente all'acqua e non ha bisogno di cure particolari.

A carry-all bag in black leather finished with a vegetable tan, can be attached to the luggage rack or fuel tank (with the appropriate band of the same colour). The bag is water resistant and does not need special care.



**BORSA PORTA ATTREZZI MARRONE
BROWN LEATHER TOOLS BAG**

.....
COD. 605991M

Borsa portatutto in cuoio naturale finito con una concia vegetale, agganciabile sul portapacchi o sul serbatoio (con l'apposita fascia dello stesso colore). La borsa è resistente all'acqua e non ha bisogno di cure particolari.

A carry-all bag in brown leather finished with a vegetable tan, can be attached to the luggage rack or fuel tank (with the appropriate band of the same colour). The bag is water resistant and does not need special care.



**SUPPORTO TARGA
LICENCE PLATE HOLDER**

.....
COD. 2S000282
COD. 2S000500 USA

Sostegno ad arco per la targa, da utilizzare in caso di montaggio del parafango in alluminio, prevede il fissaggio del gruppo ottico posteriore di serie.

Bracket support for the plate, to be used in case of Aluminium rear mudguard, is developed to allow the use of factory taillights.



**SUPPORTI FRECCHE
TURN INDICATOR BRACKETS**

.....
COD. 2S000266

Supporti in alluminio per montare le frecce posteriori nel caso di adozione del supporto porta targa 2S000282 per parafanghi in alluminio. Utilizzando questi supporti, che avvicinano gli indicatori di direzione alla sella, si rende la vista posteriore della moto più leggera e filante.

Aluminium mounting brackets for the factory rear turn indicators if a license plate bracket for 2S000282 aluminium mudguards is used. Using these brackets, these bring the turn indicators closer to the saddle, leaving the rear more free to express all the style.



**NUMERI ADESIVI
ADHESIVE NUMBERS**

.....
COD. 605983M

Il numero di Omobono "The Black Devil" Tenni, uno dei più grandi piloti della storia. Da mettere sulle tabelle frontali e laterali per viaggiare ricordando un eroe dalla storia Moto Guzzi.

Omobono "The Black Devil" Tenni's number, one of the greatest riders in history. To be applied on front and sides numberplates to remember a Moto Guzzi Legend





**CUPOLINO VERNICIATO NERO
BLACK PAINTED ALUMINIUM
TOP FAIRING**

.....
COD. 2S000178

Cupolino in alluminio verniciato fissato al corpo con supporti di acciaio inossidabile. Per donare alla tua V7 uno sguardo unico.

Painted aluminium top fairing fixed to the body with stainless steel brackets. To give your V7 a unique look.



**FIANCHETTI IN ALLUMINIO NERI
BLACK PAINTED ALUMINIUM
SIDE PANELS**

.....
COD. 2S000179

Fianchetti laterali completamente neri, per offrire alla tua V7 una superficie ininterrotta, sinuosa e perfetta.

Completely lighted, aluminium, black painted side panels to complete the black look from the first to the last centimeter.



**PARAFANGHI IN ALLUMINIO NERI
BLACK PAINTED ALUMINIUM
MUDGUARDS**

.....
COD. 2S000180

Parafanghi in alluminio alleggeriti, verniciati in nero, per completarne il look total black dal primo all'ultimo centimetro.

Lightweight aluminium mudguards, painted the same black as the V7 to complete the total black look from the first to the last centimeter.



**SERBATOIO VERNICIATO NERO
BLACK FUEL TANK**

.....
COD. 606026M
COD. 606132M USA

Serbatoio nero verniciato nello stesso colore dei particolari in alluminio della V7, per completare il look total black dal primo all'ultimo centimetro.

Fuel tank painted in the same Black color of the other aluminium parts of the V7 to complete the total black look from the first to the last centimeter.



**TABELLE IN ALLUMINIO SATINATO
SATIN ALUMINIUM NUMBER PLATES**

.....
COD. 2S000153

Tabelle portanumero in alluminio satinato a mano, due laterali e una frontale, con relativi supporti.
Per completare il look classico della V7.

Numberplates kit in hand-finished satin aluminium, with specific mounting brackets.

To complete the classic look of your V7.



**PARAFANGHI ALLUMINIO
SATINATO
LONG SATIN ALUMINIUM
MUDGUARDS**

.....
COD. 2S000152

Parafanghi lunghi in alluminio naturale, satinato a mano e di peso ridotto rispetto a quelli tradizionali.

Natural aluminium long mudguards, satin finished by hand and lighter than the conventional ones.



**COPRI INIETTORI
IN ALLUMINIO SATINATO
SATIN ALUMINIUM INJECTOR
COVERS**

.....
COD. 2S000154

Coppia di copri iniettori in alluminio naturale satinato a mano, da abbinare agli altri elementi satinati per completare il look della V7.

Two injector covers in hand-finished natural satin aluminium to replace the factory ones and to make your V7 even more elegant.



**TRAVERSINO PER MANUBRIO
CROSSBEAM FOR HANDLEBAR**

.....
COD. 605985M

Traversino per manubrio in alluminio verniciato di nero, per trasformare il manubrio di serie della tua V7 in uno da vero fuoristrada.

Crossbeam for black painted aluminium handlebar to transform the factory handlebar of your V7 into a true motorcycle handlebar.



**KIT OLIVE GREEN
OLIVE GREEN KIT**

.....
COD. 606329M

Kit completo composto da serbatoio, e parafanghi nel verde dell'Alce, storico modello Moto Guzzi. Trasforma completamente l'aspetto della V7.

Complete kit that includes the fuel tank and mudguards painted in Alce green, the historic Moto Guzzi model. It will completely transform the look of your V7.



**KIT CAMOUFLAGE
CAMOUFLAGE KIT**

.....
COD. 605990M

Kit completo composto da serbatoio, parafanghi e fianchetti laterali graficati in camouflage, per trasformare completamente l'aspetto della V7.

Complete kit that includes the fuel tank, mudguards and side panels in camouflage graphics to completely transform the look of your V7.



**PEDANE OFF ROAD PILOTA
OFF ROAD FOOTPEG KIT**

.....
COD. 2S000258

Kit di pedane pensate appositamente per l'utilizzo offroad. Consentono di non perdere l'appoggio anche nelle condizioni fuoristrada.

Footpegs kit for your V7 designed specifically for offroad use. They will help you not to lose solid footing even in off road conditions.



**ESTENSIONE PEDANA
IN ALLUMINIO LAVORATO
ALUMINIUM FOOTPEG EXTENSION**

.....
COD. 2S000320

Da applicare alle pedane offroad 2S000258 nel caso di utilizzo dello scarico 2S000311 e 2S000313. Il codice corrisponde ad una estensione pedana: è necessario ordinare due pezzi.

To be mounted on the offroad footpeg 2S000258 in case of use of exhaust 2S000311 and 2S000313. The code corresponds to one footpeg only: two pieces must be ordered.



**PUNTALE PEDALE
IN ALLUMINIO LAVORATO
ALUMINIUM FINISHED FOOTPEG
PUSH ROD**

.....
COD. 2S000323

Nel caso di utilizzo dello scarico alto 2S000311 e 2S000313. Il codice corrisponde ad un puntale pedana: è necessario ordinare due pezzi.

In case of use of high exhaust 2S000311 and 2S000313. The code corresponds to one footpeg push rod: two pieces must be ordered.



**COPPIA PEDANE PILOTA
WIDER FOOTPEGS PAIR**

.....
COD. 2S000451

Coppia di pedane maggiorate, finite con superficie zigrinata, per consentire il miglior appoggio del piede.

Pair of wider footpegs, finished with knurled surface in case of use of exhaust 2S000311 and 2S000313 to get a better support of the feet.



**SCARICO ARROW
ARROW EXHAUST**

.....
COD. 2S000311 ABS
COD. 2S000313 NO ABS
MONOCORPO/SINGLE THROTTLE BODY
COD. 2S000627 ABS versione USA / USA version

Scarico 2 in 1 con silenziatore, moderno nella tecnologia ma classico nel look. Per montare lo scarico è necessaria una staffa: se con parafrangente in alluminio 2S000325 oppure con parafrangente in plastica 2S000324.

2 in 1 exhaust system with silencer made in modern technology but with a classic look. With aluminium mudguard you need 2S000325, with plastic mudguard you need 2S000324.



**STAFFA PER SCARICO
HIGH EXHAUST SUPPORT BRACKET**

.....
COD. 2S000325
PARAFANGO ALLUMINIO
ALUMINIUM MULDGUARD
COD. 2S000324
PARAFANGO PLASTICA/PLASTIC MULDGUARD

Staffa per il montaggio dello scarico alto.
Bracket for the mounting of the high exhaust.



**SELLA CON IMBOTTITURE
PADDED SADDLE**

.....
COD. 2S000262

Sella per la tua V7 con seduta un po' più ridotta rispetto a quella di serie montata sulla moto. Perfetta per guidare in una posizione più aerodinamica e anche per permetterti, quando serve, di portare una persona. Logo Moto Guzzi ricamato.

Smaller saddle for your V7 than the one that is factory mounted on the bike. Perfect for riding in a more aerodynamic position as well as for allowing you to ride two-up when necessary. Moto Guzzi Logo embroidered.



**AMMORTIZZATORI
PERFORMANCE ROSSO
RED PERFORMANCE
SHOCK ABSORBERS**

.....
COD. 606091M
COD. 2S000257 MAGGIORATI/EXTENDED LENGHT

Con serbatoio gas separato, regolabili in estensione, compressione e precarico, migliorano comfort e guidabilità grazie alle eccezionali caratteristiche tecniche che li contraddistinguono. Molla rossa.

With separate gas tank, adjustable in size, compression and preload, improved comfort and handling thanks to exceptional technical features that distinguish them.



**SOFFIETTO FORCELLA
RUBBER FORK STANCHION
DUST BOOTS**

.....
COD. 606123M

Soffietto in gomma per proteggere gli steli della tua V7 dalla polvere, dai residui sulla strada e da qualsiasi cosa incontrerai nelle tue avventure. Il codice corrisponde ad una estensione pedana: è necessario ordinare due pezzi.

Rubber boot to protect the fork stanchions on your V7 from dust, road residue and anything else you may encounter on your adventures. The code corresponds to one dust boot: two pieces must be ordered.

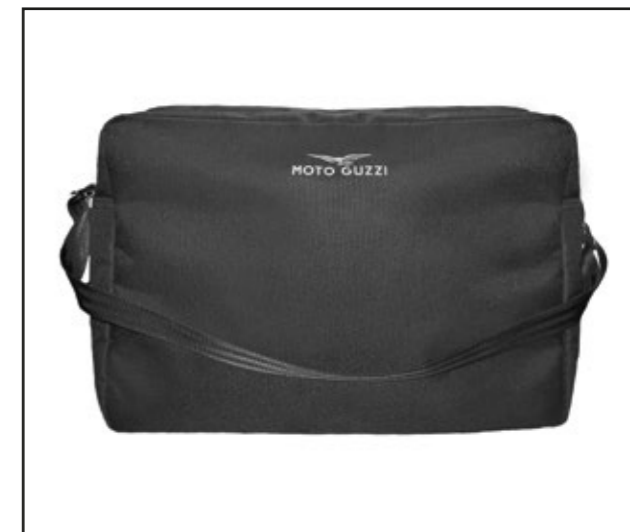

**BORSA INTERNA PER BORSA PELLE V7
INTERNAL BAG FOR V7 LEATHER BAG**

.....
COD. 606239M

In colore nero., è dotata di cerniera a doppio cursore con asole per lucchetto, tracolla ed imbottitura interna per trasportare oggetti fragili. Logo Moto Guzzi stampato.

In Black color, realized with double cursor zipper with holes for lock, shoulder belt and internal padding to transport fragile items. Printed Moto Guzzi Logo.



**PORTAPACCHI PICCOLO NERO
SMALL LUGGAGE RACK**

.....
COD. 2S000256

Un portapacchi di dimensioni ridotte in metallo verniciato nero. È pensato per agganciarci la borsa porta attrezzi, ma è perfetto anche per il tuo prossimo viaggio.

A small luggage rack in black painted metal. It is designed to attach the tool bag(605989M or 605991M), but is also perfect for your next trip.



**PNEUMATICI OFFROAD
OFFROAD TYRES**

.....
COD. 606018M

Pneumatici omologati per la V7. Il battistrada tassellato consente un'ottima tenuta su qualsiasi percorso o sentiero.

Approved offroad tyres for V7. The knobby tread provides excellent grip on any route. Or path.

MOTO GUZZI

V7 III

STONE



MOTO GUZZI®



**CORNICE FARO NERA
BLACK HEADLAMP FRAME**

.....
COD. 2S000946

Lo spirito Dark della tua V7 raggiunge l'apice con questo semplice dettaglio estetico che rende il frontale della tua moto ancora più forte e deciso.

The Dark Soul of V7 reach the top with this aesthetic detail that complete the strong and determined style of the front of Your motorcycle.



**PARABREZZAN CON STAFFE
WINDSCREEN WITH
FASTENING KIT**

.....
COD. 2S001003 Staffe nere/Black stem
COD. 2S000909 Staffe cromate/Chromed stem

Accessorio indispensabile per godere appieno del piacere di guida nelle uscite più turistiche. Il design è studiato appositamente per V7 III, si monta facilmente.

A must have to face turing rides in full comfort. Designed specifically for V7 III, is easy to mount.

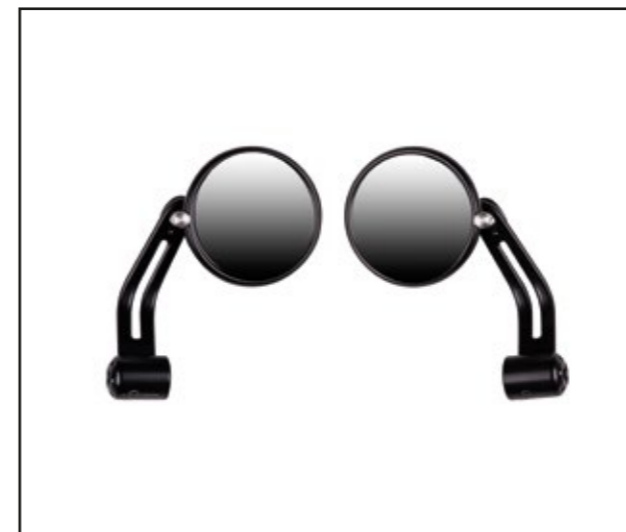

**SPECCHI MANUBRIO
HANDLEBAR MIRRORS**

.....
COD. 2S000610 Anodizzato Nero/Black Anodising
COD. 2S000261 Anodizzato Naturale/Natural Anodising

Omologati ECE, in alluminio anodizzato nero, con snodi lenticolari e viti in acciaio inox. Si fissano al manubrio lasciando la parte riflettente nella stessa posizione di quelli di serie.

ECE approved, in black painted aluminium, with lenticular ball joints and stainless steel screws. They are fixed to the handlebar, leaving the reflective part in the same position as the factory mirrors.



**SPECCHI MANUBRIO
ANODIZZATI NATURALE
ANODIZED HANDLEBAR MIRRORS**

.....
COD. 2S000911

In alluminio ricavato dal pieno con trattamento anodizzato, conferiscono al veicolo un tocco di sportività e preziosa ricerca del particolare.

In Billet aluminium CNC with anodized finishing, gives your vehicle an unmistakable sporty and rich aspect



**CUPOLINO ALLUMINIO
VERNICIATO NERO
BLACK PAINTED ALLUMINUM
TOP FAIRING**

.....
COD. 2S000896 - NERO/BLACK
COD. 2S000894 - SATINATO/SATIN

Tabella frontale portanumero in alluminio verniciato, Per dare alla tua V7 un inconfondibile stile forte e deciso.

Front numberplates Black painted. To complete the Strong and powerfull look of your V7.



**CORNICE FARO CROMATA
CHROMED HEADLAMP FRAME**

.....
COD. 2S000825

Copertura estetica e dal design moderno. Realizzata a taglio laser e piegata per armonizzarsi con il faro della moto. Logo Moto Guzzi.

Aesthetic Cover. Laser cutting and folding to be integrated with the head lamp. Moto Guzzi logo.



**COPPIA COPRIFILETTO
SPECCHI ORIGINALI
MIRROR HOLDER HOLE COVERS**

.....
COD. 2S000926 Anodizzato Nero/Black Anodising
COD. 2S000807 Anodizzato Naturale/Natural Anodising

Realizzati in alluminio ricavato dal pieno arricchiscono la zona dei comandi a manubrio coprendo gli alloggiamenti del gambo specchietto con un veri e propri gioielli. Si abbinano perfettamente agli specchi a manubrio.

These mirror holes blockoff plates are made of billet aluminium to dress up the handlebar area. These covers are the for those owners who have switched out to the bar end mirrors.



**COVER POMPA FRENO
ANTERIORE
FRONT BRAKE PUMP COVER**

.....
COD. 2S000927 Anodizzato Nero/Black Anodising
COD. 2S000817 Anodizzato Naturale/Natural Anodising

Realizzata in alluminio ricavata dal pieno arricchisce la zona dei comandi a manubrio e può essere montata facilmente senza aprire il serbatoio.

This premium reservoir cover is made of billet aluminum and dresses up the handlebar controls and can be easily mounted without opening the reservoir.



**LEVA FRENO
BRAKE LEVER**

.....
COD. 2S000569

Realizzata in alluminio ricavato dal pieno, arricchisce la zona dei comandi a manubrio garantendo anche una maggiore sicurezza grazie alla possibilità di regolazione della distanza dalla manopola.

These adjustable billet aluminum levers dress up the V7 handlebar area and increase the safety level.



**LEVA FRIZIONE
CLUTCH LEVER**

.....
COD. 2S000570

Realizzata in alluminio ricavato dal pieno, arricchisce la zona dei comandi a manubrio garantendo anche una maggiore sicurezza grazie alla possibilità di regolazione della distanza dalla manopola.

These adjustable billet aluminum levers dress up the V7 handlebar area and increase the safety level.



**COVER TAPPI FORCELLA
FORK TOP CAP COVERS**

.....
COD. 2S000928 Anodizzato Nero/Black Anodising
COD. 2B003377 Anodizzato Naturale/Natural Anodising

Realizzati in alluminio ricavato dal pieno arricchiscono il ponte di comando donando alla piastra forcella un look elegante e prezioso.

These fork top cap covers are made of billet aluminum address up the V7 fork top plate.



**PARAFANGHI IN ALLUMINIO
ALUMINIUM MUDGUARDS**

.....
COD. 2S000180 - NERO/BLACK
COD. 2S000147 - LUCIDATO/POLISHED

Parafanghi in alluminio alleggeriti, verniciati in nero, per completarne il look total black dal primo all'ultimo centimetro.

Lightweight aluminium mudguards, painted the same black as the V7 to complete the total black look from the first to the last centimeter.



**PARAFANGHI SATINATI LUNGI
LONG SATIN ALUMINIUM MUDGUARDS**

.....
COD. 2S000152

Parafanghi lunghi in alluminio naturale, satinato a mano e di peso ridotto rispetto a quelli tradizionali. Parafanghi lunghi in alluminio naturale, satinato a mano e di peso ridotto rispetto a quelli tradizionali.

Natural aluminium long mudguards, satin finished by hand and lighter than the conventional ones.



**SUPPORTO TARGA OMOLOGATO
HOMOLOGATED LICENCE
PLATE HOLDER**

.....
COD. 2S001010
COD. 2S001011 - USA

Il supporto targa, in abbinamento al parafango in alluminio Moto Guzzi cambia totalmente l'aspetto estetico della moto in tutta sicurezza, ed è omologato per l'utilizzo su strada.

In combination with aluminium mudguard, the licence plate holder change completely the look of the vehicle, in full safety as 100% street legal.



**COVER REGOLATORE DI TENSIONE
E COVER CLAXON
VOLTARE REGULATOR AND HORN
COVER**

.....
COD. 2S000808

Realizzato in alluminio ricavato dal pieno, in versione satinata, risalta la linea filante e snella della moto con una finitura ricca ed elegante.

This voltage regulator and horn cover is made of billet aluminum with satin treatment and gives a rich and elegant finishing highlighting the slim and sinuous shape of your motorcycle.



**COPPIA PROTEZIONE
COPERCHIO TESTE
CYLINDERS PROTECTION**

.....
COD. 2S000930 Anodizzato Nero/Black Anodising
COD. 2B003379 Anodizzato Naturale/Natural Anodising

Realizzati in alluminio ricavati dal pieno, proteggono la parte alta del motore donando un tocco di eleganza ed esclusività alla moto.

These cylinder head protection kits are made of billet aluminum, protect the cylinder heads and adds an elegant and exclusive touch to the vehicle shape.





**COVER GHIERE COLLETTORI
DI SCARICO
EXHAUST TUBES RING BOLT COVERS**

.....

COD. 2B003381

Finiture estetiche in acciaio tagliato al laser, permettono di abbellire la parte frontale degli scarichi con un tocco di eleganza ed originalità.

Exhaust flange accent cover made of laser cut steel, adds some extra elegance and originality to the exhaust flange of your vehicle.



**COPRI INIETTORI ANODIZZATI
ANODIZED INJECTION COVER**

.....

COD. 2S000901

in alluminio naturale anodizzato, impreziosiscono la parte centrale della V7III.

In natural anodized aluminium, enrich the central part of your V7 III.



**PANNELLI LATERALI ALLUMINIO
ALLUMINIUM SIDE PLATES**

.....

COD. 2S000895 - NERO/BLACK

COD. 2S000890 - SATINATI/SATIN

Fianchetti laterali in alluminio completamente neri, per offrire alla tua V7 una superficie ininterrotta, sinuosa e perfetta.

Completely lighted, black painted aluminium side panels to complete the dark look from the first to the last centimeter.



**CINGHIA SERBATOIO
TANK BELT**

.....

COD. 606487M

COD. 2S000992 GANCIO SERBATOIO/BELT HOLDER

In pregiata pelle, con logo Moto Guzzi, dona al serbatoio uno stile unico ed elegante, che sottolinea la tradizione di tutte le Moto Guzzi. Necessita dell'apposito gancio di fissaggio 2S000992.

In premium leather, with Moto Guzzi Logo, gives the tank an exclusive and elegant look, highlighting the Moto Guzzi Heritage. Needs mounting hook 2S000992.

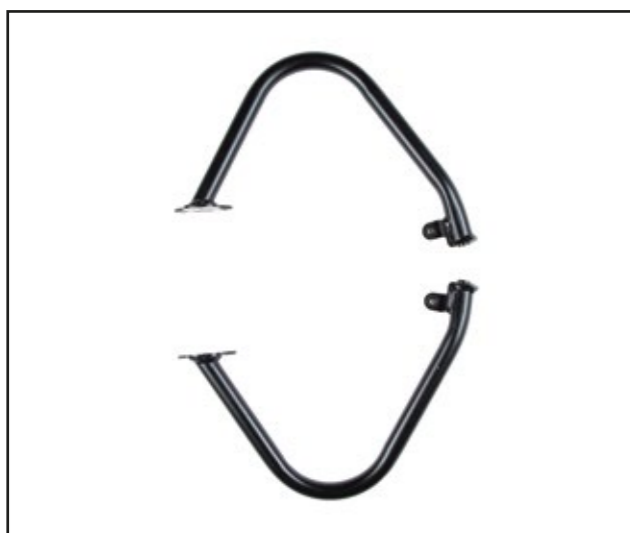

**PARAMOTORE TUBOLARE
ENGINE GUARD**

.....

COD. 2S000914 Anodizzato Nero/Black Anodising

COD. 2S001006 Anodizzato Naturale/Natural Anodising

Disegnato dal Centro Stile Moto Guzzi, offre una protezione specifica al motore ed alle gambe del pilota. Il suo disegno segue con armonia le linee del veicolo, unendo stile alla funzionalità.

Designed by the Moto Guzzi Style Dept. it offers a protection for the engine or for the rider's legs. The specific soft curve shape adds style to functionality.



**COPPIA GOMME PEDANE
ANTIVIBRANTE
RUBBER FOOTHOLDER**

.....

COD. 2S000167

Il kit gommini pedane antivibrante aumentano il comfort di guida e danno un appoggio sul veicolo più sicuro.

This kit improve the riding comfort and the control of the body of the vehicle



**PEDANE OFF ROAD
OFF ROAD FOOTPEG**

.....

COD. 2S000258

Kit di pedane pensate appositamente per l'utilizzo offroad. Consentono di non perdere l'appoggio anche nelle condizioni fuoristrada.

Footpegs kit for your V7 designed specifically for offroad use. They will help you not to lose solid footing even in off road conditions.



**TRAVERSINO PER MANUBRIO
CROSSBEAM FOR HANDLEBAR**

.....

COD. 605985M

Traversino per manubrio in alluminio verniciato di nero, per trasformare il manubrio di serie della tua V7 in uno da vero fuoristrada.

Crossbeam for black painted aluminium handlebar to transform the factory handlebar of your V7 into a true motorcycle handlebar.



**SELLA CON IMBOTTITURE
PADDED SADDLE**

.....
COD. 2S000262

Sella trapuntata per la tua V7 con seduta un po' più ridotta rispetto a quella di serie montata sulla moto. Perfetta per guidare in una posizione più aerodinamica e anche per permetterti, quando serve, di portare una persona. Logo Moto Guzzi ricamato.

Smaller saddle for your V7 than the one that is factory mounted on the bike. Perfect for riding in a more aerodynamic position as well as for allowing you to ride two-up when necessary. Moto Guzzi Logo embroidered.



**SELLA MONOPOSTO PREMIUM
PREMIUM SINGLE-SEAT SADDLE**

.....
COD. 2S000260

Sella sportiva monoposto, caratterizzata da imbottiture elettrosaldate e cucite. Logo Moto Guzzi ricamato.

Single-seat sport saddle with electro-welded and stitched padding. Moto Guzzi Logo embroidered.



**SELLA AD UN POSTO E MEZZO
ONE AND A HALF SEAT SADDLE**

.....
COD. 2S000265

Sella con seduta ridotta rispetto a quella di serie montata sulla moto. Perfetta per guidare in una posizione più aerodinamica e anche per permetterti, quando serve, di portare una persona. Logo Moto Guzzi ricamato.

Smaller saddle for your V7 than the one that is factory mounted on the bike. Perfect for riding in a more aerodynamic position as well as for allowing you to ride two-up when necessary. Moto Guzzi Logo embroidered.



**SELLA MONOPOSTO
SINGLE-SEAT SADDLE**

.....
COD. 606124M

Sella sportiva monoposto, basata sulla linea della classica V7 Café.

Single-seat sport saddle based on the classic V7 Café line.



**SELLA MARRONE PREMIUM
BRAWN PREMIUM SADDLE**

.....
COD. 2S000922

La sella premium rende V7 un veicolo davvero esclusivo ed unico con un livello di finiture e qualità dei materiali di categoria superiore.

This saddle gives V7 a unique and exclusive status thanks to precious finishing and superior materials.



**SELLA LADY BIKE
BRAWN PREMIUM SADDLE**

.....
COD. 2S000921

la sella Lady utilizza materiali design e finiture davvero unici, che ne sottolineano il tocco femminile.

Materials, design and finishing of this saddle are giving V7 an unmistakable Lady style.



**SELLA COMFORT GEL
COMFORT GEL SADDLE**

.....
COD. B063597

Sella biposto con inserti in gel nelle zone pilota e passeggero. Oltre al comfort, offre un maggior appoggio a terra grazie al diverso disegno dello schiumato. Logo "Comfort Gel" punzonato.

Two seat saddle with gel inserts in the driver and passenger area. Besides comfort, it offers better contact with ground due to the different design of the foamed structure. Punched "Comfort Gel" logo.



**SELLA RIBASSATA COMFORT GEL
LOWER COMFORT GEL SADDLE**

.....
COD. B063598

Biposto, unisce il comfort del gel alla comodità del profilo rivisto e ribassato, per consentire al pilota un migliore e più sicuro appoggio a terra. Logo "Comfort Gel" punzonato.

Two-seated, combines the comfort given by the gel with the revised and lowered profile, to allow the driver to have a better and safer contact with the ground. Punched "Comfort Gel" logo.





**COPPIA COVER PEDANE
POGGIAPIEDI
FOOTPEGS COVER**

.....
COD. 2S000933 Anodizzato Nero/Black Anodising
COD. 2B003376 Anodizzato Naturale/Natural Anodising

In prezioso alluminio ricavato dal pieno garantiscono alle pedane un aspetto più elegante e un appoggio stabile e sicuro grazie ad una fresatura ordinata ed efficace.

Billet footpeg covers made of billet aluminum, with a nicer, more elegant look and a more stable and safe contact with the V7 during riding, thanks to its grippy knurled surface



**COPPIA COVER PEDANE
POGGIAPIEDI PASSEGGERO
PASSENGER FOOTPEGS COVER**

.....
COD. 2S000809

In prezioso alluminio ricavato dal pieno garantiscono alle pedane un aspetto più elegante, e garantiscono un appoggio stabile e sicuro grazie ad una fresatura ordinata ed efficace.
Billet footpeg covers made of billet aluminum, with a nicer, more elegant look and a more stable and safe contact with the V7 during riding, thanks to its grippy knurled surface.

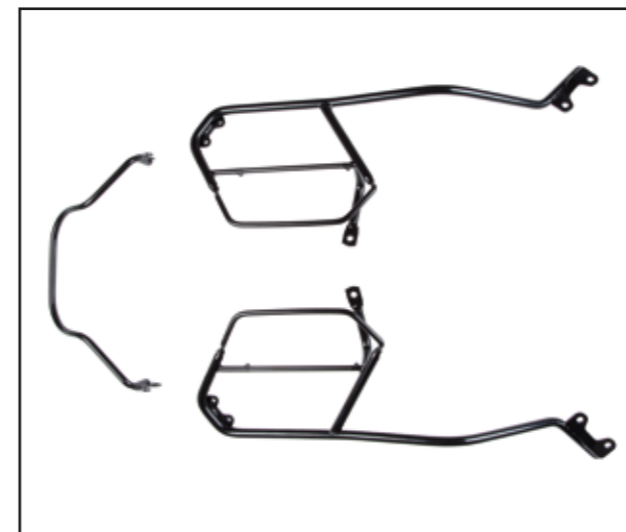

**SUPPORTI BORSE LATERALI
SIDE BAGS SUPPORT**

.....
COD. 2S000887

Questi supporti, dalla linea snella ed armoniosa, in un'elegante verniciatura nera, mantengono invariato il look del veicolo, e consentono di utilizzare tutte le borse laterali a sgancio rapido dedicate della linea Moto Guzzi.

These sidebag supports were developed in conjunction with the vehicle and are necessary to mount the sidebags. Black finish, streamlined and styled with the bike. These maintain the vehicle's looks and allow the use of all Moto Guzzi quick release side bags.



**BORSE PELLE CON SGANCIO RAPIDO
LEATHER QUICK RELEASE SIDE BAGS**

.....
COD. 2S000522

Pelle di prima scelta, cura dei dettagli ed una finitura che rispecchia la concia artigianale delle pelletterie italiane. Sono dotate di uno sgancio rapido e di sistema di sicurezza antifurto che ne permettono un comodo utilizzo, dal quotidiano al viaggio. Necessitano degli appositi supporti Fast Click.

These quick release side bags are made of made of premium Italian leather, are equipped with a quick release and safe locking system, useful on everything from daily trips to long trips. Comes with carrying strap. Installation requires Fast Click mounting supports.



**PEDALINO FRENO
BRAKE LEVER PAD**

.....
COD. 2S000932 Anodizzato Nero/Black Anodising
COD. 2S000812 Anodizzato Naturale/Natural Anodising

Il pedalino, realizzato in alluminio ricavato dal pieno, permette un più solido e sicuro azionamento del pedale del freno garantendo allo stesso tempo un design ed un impatto estetico più prezioso ed importante.

Extra wide brake lever peg made of billet aluminum, increase safety when using the rear brake lever and at the same time enhances design and richness of the Vehicle



**COVER POMPA FRENO
POSTERIORE
REAR BRAKE COVER**

.....
COD. 2S000931 Anodizzato Nero/Black Anodising
COD. 2S000818 Anodizzato Naturale/Natural Anodising

Questi supporti, dalla linea snella ed armoniosa, in un'elegante verniciatura nera, mantengono invariato il look del veicolo, e consentono di utilizzare tutte le borse laterali a sgancio rapido dedicate della linea Moto Guzzi.

These sidebag supports were developed in conjunction with the vehicle and are necessary to mount the sidebags. Black finish, streamlined and styled with the bike. These maintain the vehicle's looks and allow the use of all Moto Guzzi quick release side bags.



**BORSE LATERALI CANVAS
CANVAS SIDE BAGS**

.....
COD. 2S000907

In pregiato tessuto e rifiniture in pelle, queste borse morbide si applicano facilmente e velocemente agli appositi supporti grazie agli attacchi Fast Click. Necessitano del kit montaggio Fast Click specifico.

In precious fabric and leather finishing, these bags can be easily and quickly applied on the vehicle thanks to Fast Click release system. Needs Fast Click specific mounting support.



**BORSE LATERALI TOURING CON
SGANCIO RAPIDO
QUICK RELEASE TOURING SIDE BAGS**

.....
COD. 2S000731

Le borse laterali da turismo, in tessuto tecnico, hanno robustezza e capienza che la rendono indispensabile per intraprendere lunghi viaggi. Dotate di sgancio rapido e sistema di sicurezza antifurto che ne permettono un comodo utilizzo. Necessitano degli appositi supporti Fast Click.

These quick release side bags are made of made of cordura with leather inserts, are weather resistant and are equipped with a quick release and safe locking system, useful on everything from daily trips to long trips. Comes with carrying strap. Installation requires fast Click mounting supports.



**BORSA BAULETTO
SEMIRIGIDA CUOIO
REAR SEMI RIGID BAG**

.....
COD. 2B003372

Realizzata con una perfetta combinazione tra pelle e tessuto tencico, permette di alloggiare sul portapacchi posteriore un bagaglio sufficiente a vivere un'esperienza di viaggio intensa e prolungata.

This semi-rigid rear bag mounts easily to the rear rack and is made of a perfect balance of leather and technical textile panels.



**PORTAPACCHI NERO
BLACK REAR RACK**

.....
COD. 2S000888

Il portapacchi posteriore, con finitura nera, è il supporto ideale per un bagaglio compatto o per il bauletto posteriore dedicato a V7.

This black rear rack improve the elegant shape of V7 and is needed to support the rear top box.



**MOLLE AMMORTIZZATORI ROSSE
RED SHOCK ABSORBER SPRINGS**

.....
COD. 2S000906

Accentua lo spirito sportivo e l'immagine café racer della tua V7 con le molle ammortizzatori in colorazione Rosso Moto Guzzi.

Enhance the racing spirit and café racer style of your V7 with these Moto Guzzi red shock absorber springs.



**PORTAPACCHI PICCOLO
VERNICIATO NERO
SMALL LUGGAGE RACK**

.....
COD. 2S000256

Un portapacchi di dimensioni ridotte in metallo verniciato nero. È pensato per agganciarci la borsa porta attrezzi, ma è perfetto anche per il tuo prossimo viaggio.

A small luggage rack in black painted metal. It is designed to attach the tool bag, but is also perfect for your next trip.



**COVER AMMORTIZZATORI
POSTERIORE
REAR SHOCK ABSORBER**

.....
COD. 2S000811

Realizzate in alluminio ricavato dal pieno, queste cover rendono ancora più preziosa la parte posteriore della tua V7, sottolineando l'utilizzo di materiali di pregio per i componenti, che rendano l'estetica del veicolo più filante ma allo stesso tempo più ricca ed appariscente.

These billet aluminum rear shock absorber covers dress up the rear part of V7. Not compatible with the sidebag mounting racks or luggage rack.

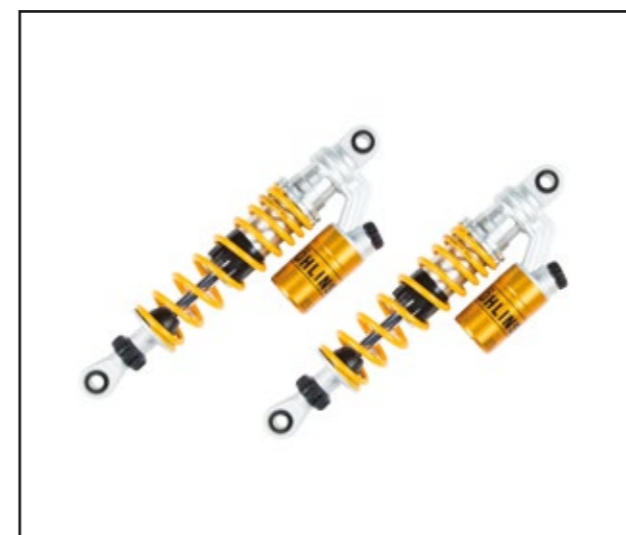

**AMMORTIZZATORI OHLINS RACER
OHLINS RACER SHOCK ABSORBERS**

.....
COD. 606669M

Gli ammortizzatori Ohlins per V7 danno alla tua moto un'immagine Racing e garantiscono una guida e tenuta di strada da vera moto da corsa.

These shock absorbers give your V7 an unmistakable Racing look and a roadholding comparable to professional Sport motorbikes





GUZZI MULTIMEDIA PLATFORM

.....
 COD. 606522M
 COD. 2S000912 kit installazione / installation kit

MGMP è il nuovo dispositivo che consente di collegare il proprio Smartphone alla moto, trasformandola in una vera e propria piattaforma multimediale. Necessita del kit di installazione 2S000912.

MGMP is the new device that allows you to connect your smartphone to the motorcycle, turning it to a real multimedia platform. Needs installation kit 2S000912.



**KIT INSTALLAZIONE PRESA USB
 USB SOCKET INSTALLATION KIT**

.....
 COD. 2S000983

Preso USB fornita di supporto dedicato per installazione nel sottosella, per la ricarica dei supporti elettronici, non consente il dialogo con gli apparati elettronici del mezzo.

USB socket with bracket for installation under the saddle, to recharge the electronic media, does not allow dialogue with the electronic devices of the vehicle.



**TELO COPRIMOTO V7
 V7 BIKE COVER**

.....
 COD. 895729

Telo su misura da interno per la protezione dalla polvere da utilizzare durante le soste in garage della moto. È realizzato in un tessuto elasticizzato con grafica speciale.

Tailor-made motorcycle cover for inside use to protect against dust, intended for use during long periods of storing the bike in a garage. It is made of stretch fabric with special graphics.



**TELO COPRIMOTO "EAGLE"
 "EAGLE" BIKE COVER**

.....
 COD. 606028M0001

Telo su misura da interno per la protezione dalla polvere da utilizzare durante le soste in garage della moto. È realizzato in un tessuto elasticizzato con grafica speciale.

Tailor-made motorcycle cover for inside use to protect against dust, intended for use during long periods of storing the bike in a garage. It is made of stretch fabric with special graphics.



**ANTIFURTO ELETTRONICO
 ANTITHEFT SYSTEM**

.....
 COD. 606423M
 COD. 2S000978 kit installazione / installation kit

Protegge la tua moto grazie alla centralina compatta e tecnologicamente avanzata. Permette una facile e discreta installazione ed è dotata di telecomando. Il sistema è autoalimentato ed ha un assorbimento energetico minimo. Necessita kit di installazione.

This electronic antitheft system protect your vehicle. The electronic box is very small and packed with advanced technology, and allow an easy and invisible installation. This system has a battery backup and a very low power drain. Includes a remote control. need mounting kit.



**PNEUMATICI OFFROAD
 OFFROAD TYRES**

.....
 COD. 606018M

Pneumatici omologati per la V7. Il battistrada tassellato consente un'ottima tenuta su qualsiasi percorso o sentiero.

Approved offroad tyres for V7. The knobby tread provides excellent grip on any route. Or path.



**TELO COPRIMOTO "SHAPE"
 "SHAPE" BIKE COVER**

.....
 COD. 606028M0002

Telo su misura da interno per la protezione dalla polvere da utilizzare durante le soste in garage della moto. È realizzato in un tessuto elasticizzato con grafica speciale.

Tailor-made motorcycle cover for inside use to protect against dust, intended for use during long periods of storing the bike in a garage. It is made of stretch fabric with special graphics.

V7 III

SPECIAL



MOTO GUZZI®



**PARABREZZA CON STAFFE
WINDSCREEN WITH
FASTENING KIT**

.....
COD. 2S000909 Staffe cromate/Chromed stem
COD. 2S001003 Staffe nere/Black stem

Accessorio indispensabile per godere appieno del piacere di guida nelle uscite più turistiche. Il design è studiato appositamente per V7 III, si monta facilmente.

A must have to face turing rides in full comfort. Designed specifically for V7 III, is easy to mount.



**CORNICE FARO CROMATA
CHROMED HEADLAMP FRAME**

.....
COD. 2S000825

Copertura estetica e dal design moderno. Realizzata a taglio laser e piegata per armonizzarsi con il faro della moto. Logo Moto Guzzi.

Aesthetic Cover. Laser cutting and folding to be integrated with the head lamp. Moto Guzzi logo.



**CORNICE FARO NERA
BLACK HEADLAMP FRAME**

.....
COD. 2S000946

Lo spirito Dark della tua V7 raggiunge l'apice con questo semplice dettaglio estetico che rende il frontale della tua moto ancora più forte e deciso.

The Dark Soul of V7 reach the top with this aesthetic detail that complete the strong and determined style of the front of Your motorcycle.



**COVER POMPA FRENO
ANTERIORE
FRONT BRAKE PUMP COVER**

.....
COD. 2S000817 Anodizzato Naturale/Natural Anodising
COD. 2S000927 Anodizzato Nero/Black Anodising

Realizzata in alluminio ricavata dal pieno arricchisce la zona dei comandi a manubrio e può essere montata facilmente senza aprire il serbatoio.

This premium reservoir cover is made of billet aluminum and dresses up the handlebar controls and can be easily mounted without opening the reservoir.



**CUPOLINO ALLUMINIO
VERNICIATO NERO
BLACK PAINTED ALLUMINIUM
TOP FAIRING**
.....

COD. 2S000896 - NERO/BLACK
COD. 2S000894 - SATINATO/SATIN

Tabella frontale portanumero in alluminio verniciato,
Per dare alla tua V7 un inconfondibile stile forte e deciso.

*Front numberplates Black painted. To complete the Strong
and powerfull look of your V7.*



**SPECCHI MANUBRIO
ANODIZZATI NATURALE
ANODIZED HANDLEBAR MIRRORS**
.....

COD. 2S000911

In alluminio ricavato dal pieno con trattamento anodizzato,
conferiscono al veicolo un tocco di sportività e preziosa ricer-
ca del particolare.

*In Billet aluminium CNC with anodized finishing, gives your
vehicle an unmistakable sporty and rich aspect*



**PANNELLI LATERALI ALLUMINIO
ALLUMINIUM SIDE PLATES**
.....

COD. 2S000890 - SATINATI/SATIN
COD. 2S000895 - NERO/BLACK

Fianchetti laterali in alluminio completamente neri, per
offrire alla tua V7 una superficie ininterrotta, sinuosa e
perfetta.

*Completely lighted, black painted aluminium side panels to
complete the dark look from the first to the last centimeter.*



**SUPPORTO TARGA OMOLOGATO
HOMOLOGATED LICENCE
PLATE HOLDER**
.....

COD. 2S001010
COD. 2S001011 - USA

Il supporto targa, in abbinamento al parafrangente in alluminio
Moto Guzzi cambia totalmente l'aspetto estetico della moto
in tutta sicurezza, ed è omologato per l'utilizzo su strada.

*In combination with aluminium mudguard, the licence
plate holder change completely the look of the vehicle, in
full safety as 100% street legal.*



**SPECCHI MANUBRIO BLACK MAT
BLACK HANDLEBAR MIRRORS**
.....

COD. 2S000261 Anodizzato Naturale/Natural Anodising
COD. 2S000610 Anodizzato Nero/Black Anodising

Omologati ECE, in alluminio anodizzato nero, con snodi
lenticolari e viti in acciaio inox. Si fissano al manubrio
lasciando la parte riflettente nella stessa posizione di quelli
di serie.

*ECE approved, in black painted aluminium, with lenticular
ball joints and stainless steel screws. They are fixed to the
handlebar, leaving the reflective part in the same position
as the factory mirrors.*



**COPPIA COPRIFILETTO
SPECCHI ORIGINALI
MIRROR HOLDER HOLE COVERS**
.....

COD. 2S000807 Anodizzato Naturale/Natural Anodising
COD. 2S000926 Anodizzato Nero/Black Anodising

Realizzati in alluminio ricavato dal pieno arricchiscono la
zona dei comandi a manubrio coprendo gli alloggiamenti del
gambo specchietto con un veri e propri gioielli. Si abbinano
perfettamente agli specchi a manubrio.

*These mirror holes blockoff plates are made of billet alu-
minium to dress up the handlebar area. These covers are
the for those owners who have switched out to the bar end
mirrors.*



**PEDALINO FRENO
BRAKE LEVER PAD**
.....

COD. 2S000812 Anodizzato Naturale/Natural Anodising
COD. 2S000932 Anodizzato Nero/Black Anodising

Il pedalino, realizzato in alluminio ricavato dal pieno,
permette un più solido e sicuro azionamento del pedale del
freno garantendo allo stesso tempo un design ed un impatto
estetico più prezioso ed importante.

*Extra wide brake lever peg made of billet aluminium, incre-
ase safety when using the rear brake lever and at the same
time enhances design and richness of the Vehicle*



**CINGHIA SERBATOIO
TANK BELT**
.....

COD. 606487M
COD. 2S000992 GANCIO SERBATOIO/BELT HOLDER

In pregiata pelle, con logo Moto Guzzi, dona al serbatoio uno
stile unico ed elegante, che sottolinea la tradizione di tutte
le Moto Guzzi. Necessita dell'apposito gancio di fissaggio
2S000992.

*in premium leather, with Moto Guzzi Logo, gives the tank
an exclusive and elegant look, highlighting the Moto Guzzi
Heritage. Needs mounting hook 2S000992.*



**LEVA FRIZIONE
CLUTCH LEVER**

.....
COD. 2S000570

Realizzata in alluminio ricavato dal pieno, arricchisce la zona dei comandi a manubrio garantendo anche una maggiore sicurezza grazie alla possibilità di regolazione della distanza dalla manopola.

These adjustable billet aluminum levers dress up the V7 handlebar area and increase the safety level.



**LEVA FRENO
BRAKE LEVER**

.....
COD. 2S000569

Realizzata in alluminio ricavato dal pieno, arricchisce la zona dei comandi a manubrio garantendo anche una maggiore sicurezza grazie alla possibilità di regolazione della distanza dalla manopola.

These adjustable billet aluminum levers dress up the V7 handlebar area and increase the safety level.



**PARAMOTORE TUBOLARE
ENGINE GUARD**

.....
COD. 2S001006 Anodizzato Naturale/Natural Anodising
COD. 2S000914 Anodizzato Nero/Black Anodising

Disegnato dal Centro Stile Moto Guzzi, offre una protezione specifica al motore ed alle gambe del pilota. Il suo disegno segue con armonia le linee del veicolo, unendo stile alla funzionalità.

Designed by the Moto Guzzi Style Dept. it offers a protection for the engine or for the rider's legs. The specific soft curve shape adds style to functionality.



**COPRI INIETTORI ANODIZZATI
ANODIZED INJECTION COVER**

.....
COD. 2S000901

in alluminio naturale anodizzato, impreziosiscono la parte centrale della V7III.

In natural anodized aluminium, enrich the central part of your V7 III.



**COVER TAPPI FORCELLA
FORK CAP TOP COVERS**

.....
COD. 2B003377 Anodizzato Naturale/Natural Anodising
COD. 2S000928 Anodizzato Nero/Black Anodising

Realizzati in alluminio ricavato dal pieno arricchiscono il ponte di comando donando alla piastra forcella un look elegante e prezioso.

These fork top cap covers are made of billet aluminum and dress up the V7 fork top plate.



**COVER REGOLATORE DI TENSIONE
E COVER CLAXON
VOLTAGE REGULATOR AND HORN COVER**

.....
COD. 2S000808

Realizzato in alluminio ricavato dal pieno, in versione satinata, risalta la linea filante e snella della moto con una finitura ricca ed elegante.

This voltage regulator and horn cover is made of billet aluminum with satin treatment and gives a rich and elegant finishing highlighting the slim and sinuous shape of your motorcycle.



**COVER GHIERE COLLETTORI
DI SCARICO
EXHAUST TUBES RING BOLT COVERS**

.....
COD. 2B003381

Finiture estetiche in acciaio tagliato al laser, permettono di abbellire la parte frontale degli scarichi con un tocco di eleganza ed originalità.

Exhaust flange accent cover made of laser cut steel, adds some extra elegance and originality to the exhaust flange of your vehicle.



**COPPIA PROTEZIONE
COPERCHIO TESTE
CYLINDERS PROTECTION**

.....
COD. 2B003379 Anodizzato Naturale/Natural Anodising
COD. 2S000930 Anodizzato Nero/Black Anodising

Realizzati in alluminio ricavati dal pieno, proteggono la parte alta del motore donando un tocco di eleganza ed esclusività alla moto.

These cylinder head protection kits are made of billet aluminum, protect the cylinder heads and adds an elegant and exclusive touch to the vehicle shape.

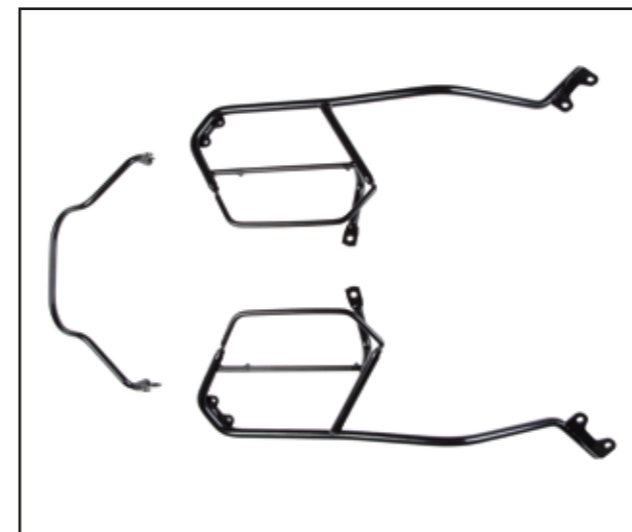

**SUPPORTI BORSE LATERALI
SIDE BAGS SUPPORT**

.....
COD. 2S000887

Questi supporti, dalla linea snella ed armoniosa, in un'elegante verniciatura nera, mantengono invariato il look del veicolo, e consentono di utilizzare tutte le borse laterali a sgancio rapido dedicate della linea Moto Guzzi.

These sidebag supports were developed in conjunction with the vehicle and are necessary to mount the sidebags. Black finish, streamlined and styled with the bike. These maintain the vehicle's looks and allow the use of all Moto Guzzi quick release side bags.



**BORSE PELLE CON SGANCIO RAPIDO
LEATHER QUICK RELEASE SIDE BAGS**

.....
COD. 2S000522

Pelle di prima scelta, cura dei dettagli ed una finitura che rispecchia la concia artigianale delle pelletterie italiane. Sono dotate di uno sgancio rapido e di sistema di sicurezza antifurto che ne permettono un comodo utilizzo, dal quotidiano al viaggio. Necessitano degli appositi supporti Fast Click

These quick release side bags are made of made of premium Italian leather, are equipped with a quick release and safe locking system, useful on everything from daily trips to long trips. Comes with carrying strap. Installation requires Fast Click mounting supports.



**BORSE LATERALI CANVAS
CANVAS SIDE BAGS**

.....
COD. 2S000907

In pregiato tessuto e rifiniture in pelle, queste borse morbide si applicano facilmente e velocemente agli appositi supporti grazie agli attacchi Fast Click. Necessitano del kit montaggio Fast Click specifico.

In precious fabric and leather finishing, these bags can be easily and quickly applied on the vehicle thanks to Fast Click release system. Needs Fast Click specific mounting support.



**BORSE LATERALI TOURING CON
SGANCIO RAPIDO
QUICK RELEASE TOURING SIDE BAGS**

.....
COD. 2S000731

Le borse laterali da turismo, in tessuto tecnico, hanno robustezza e capienza che la rendono indispensabile per intraprendere lunghi viaggi. Dotate di sgancio rapido e sistema di sicurezza antifurto che ne permettono un comodo utilizzo. Necessitano degli appositi supporti Fast Click.

These quick release side bags are made of made of cordura with leather inserts, are weather resistant and are equipped with a quick release and safe locking system, useful on everything from daily trips to long trips. Comes with carrying strap. Installation requires fast Click mounting supports.



**SELLA MARRONE PREMIUM
BRAWN PREMIUM SADDLE**

.....
COD. 2S000922

La sella premium rende V7 un veicolo davvero esclusivo ed unico con un livello di finiture e qualità dei materiali di categoria superiore.

This saddle gives V7 a unique and exclusive status thanks to precious finishing and superior materials.



**SELLA LADY BIKE
BRAWN PREMIUM SADDLE**

.....
COD. 2S000921

la sella Lady utilizza materiali design e finiture davvero unici, che ne sottolineano il tocco femminile.

Materials, design and finishing of this saddle are giving V7 an unmistakable Lady style.



**SELLA AD UN POSTO E MEZZO
ONE AND A HALF SEAT SADDLE**

.....
COD. 2S000265

Sella con seduta ridotta rispetto a quella di serie montata sulla moto. Perfetta per guidare in una posizione più aerodinamica e anche per permetterti, quando serve, di portare una persona. Logo Moto Guzzi ricamato.

Smaller saddle for your V7 than the one that is factory mounted on the bike. Perfect for riding in a more aerodynamic position as well as for allowing you to ride two-up when necessary. Moto Guzzi Logo embroidered



**SELLA MONOPOSTO
SINGLE-SEAT SADDLE**

.....
COD. 606124M

Sella sportiva monoposto, basata sulla linea della classica V7 Café.

Single-seat sport saddle based on the classic V7 Café line.



**SELLA CON IMBOTTITURE
PADDED SADDLE**

.....
COD. 2S000262

Sella trapuntata per la tua V7 con seduta un po' più ridotta rispetto a quella di serie montata sulla moto. Perfetta per guidare in una posizione più aerodinamica e anche per permetterti, quando serve, di portare una persona. Logo Moto Guzzi ricamato.

Smaller saddle for your V7 than the one that is factory mounted on the bike. Perfect for riding in a more aerodynamic position as well as for allowing you to ride two-up when necessary. Moto Guzzi Logo embroidered.



**SELLA MONOPOSTO PREMIUM
PREMIUM SINGLE-SEAT SADDLE**

.....
COD. 2S000260

Sella sportiva monoposto, caratterizzata da imbottiture elettrosaldate e cucite. Logo Moto Guzzi ricamato.

Single-seat sport saddle with electro-welded and stitched padding. Moto Guzzi Logo embroidered.



**SELLA COMFORT GEL
COMFORT GEL SADDLE**

.....
COD. B063597

Sella biposto con inserti in gel nelle zone pilota e passeggero. Oltre al comfort, offre un maggior appoggio a terra grazie al diverso disegno dello schiumato. Logo "Comfort Gel" punzonato.

Two seat saddle with gel inserts in the driver and passenger area. Besides comfort, it offers better contact with ground due to the different design of the foamed structure. Punched "Comfort Gel" logo.



**SELLA RIBASSATA COMFORT GEL
LOWER COMFORT GEL SADDLE**

.....
COD. B063598

Biposto, unisce il comfort del gel alla comodità del profilo rivisto e ribassato, per consentire al pilota un migliore e più sicuro appoggio a terra. Logo "Comfort Gel" punzonato.

Two-seated, combines the comfort given by the gel with the revised and lowered profile, to allow the driver to have a better and safer contact with the ground. Punched "Comfort Gel" logo.



**COPPIA COVER PEDANE
POGGIAPIEDI
FOOTPEGS COVER**
.....

COD. 2B003376 Anodizzato Naturale/Natural Anodising
COD. 2S000933 Anodizzato Nero/Black Anodising

In prezioso alluminio ricavato dal pieno garantiscono alle pedane un aspetto più elegante e un appoggio stabile e sicuro grazie ad una fresatura ordinata ed efficace.

Billet footpeg covers made of billet aluminum, with a nicer, more elegant look and a more stable and safe contact with the V7 during riding, thanks to its grippy knurled surface



**COPPIA COVER PEDANE
POGGIAPIEDI PASSEGGERO
PASSENGER FOOTPEGS COVER**
.....

COD. 2S000809

In prezioso alluminio ricavato dal pieno garantiscono alle pedane un aspetto più elegante, e garantiscono un appoggio stabile e sicuro grazie ad una fresatura ordinata ed efficace.

Billet footpeg covers made of billet aluminum, with a nicer, more elegant look and a more stable and safe contact with the V7 during riding, thanks to its grippy knurled surface.



**MOLLE AMMORTIZZATORI ROSSE
RED SHOCK ABSORBER SPRINGS**
.....

COD. 2S000906

Accentua lo spirito sportivo e l'immagine café racer della tua V7 con le molle ammortizzatori in colorazione Rosso Moto Guzzi.

Enhance the racing spirit and café racer style of your V7 with these Moto Guzzi red shock absorber springs.



**AMMORTIZZATORI OHLINS RACER
OHLINS RACER SHOCK ABSORBERS**
.....

COD. 606669M

Gli ammortizzatori Ohlins per V7 danno alla tua moto un'immagine Racing e garantiscono una guida e tenuta di strada da vera moto da corsa.

These shock absorbers give your V7 an unmistakable Racing look and a roadholding comparable to professional Sport motorbikes



**COVER POMPA FRENO POSTERIORE
REAR BRAKE COVER**
.....

COD. 2S000818 Anodizzato Naturale/Natural Anodising
COD. 2S000931 Anodizzato Nero/Black Anodising

Questi supporti, dalla linea snella ed armoniosa, in un'elegante verniciatura nera, mantengono invariato il look del veicolo, e consentono di utilizzare tutte le borse laterali a sgancio rapido dedicate della linea Moto Guzzi.

These sidebag supports were developed in conjunction with the vehicle and are necessary to mount the sidebags. Black finish, streamlined and styled with the bike. These maintain the vehicle's looks and allow the use of all Moto Guzzi quick release side bags.



**COVER AMMORTIZZATORI
POSTERIORE
REAR SHOCK ABSORBER**
.....

COD. 2S000811

Realizzate in alluminio ricavato dal pieno, queste cover rendono ancora più preziosa la parte posteriore della tua V7, sottolineando l'utilizzo di materiali di pregio per i componenti, che rendono l'estetica del veicolo più filante ma allo stesso tempo più ricca ed appariscente.

These billet aluminum rear shock absorber covers dress up the rear part of V7. Not compatible with the sidebag mounting racks or luggage rack.



**PARAFANGHI IN ALLUMINIO
ALUMINIUM MUDGUARDS**
.....

COD. 2S000147 - LUCIDATO/POLISHED
COD. 2S000180 - NERO/BLACK

Parafanghi in alluminio alleggeriti, verniciati in nero, per completarne il look total black dal primo all'ultimo centimetro.

Lightweight aluminium mudguards, painted the same black as the V7 to complete the total black look from the first to the last centimeter.



**PARAFANGHI SATINATI LUNGH
LONG SATIN ALUMINIUM MUDGUARDS**
.....

COD. 2S000152

Parafanghi lunghi in alluminio naturale, satinato a mano e di peso ridotto rispetto a quelli tradizionali. Parafanghi lunghi in alluminio naturale, satinato a mano e di peso ridotto rispetto a quelli tradizionali.

Natural aluminium long mudguards, satin finished by hand and lighter than the conventional ones.



**BORSA BAULETTO
SEMIRIGIDA CUIOIO
REAR SEMI RIGID BAG**

.....
COD. 2B003372

Realizzata con una perfetta combinazione tra pelle e tessuto tencico, permette di alloggiare sul portapacchi posteriore un bagaglio sufficiente a vivere un'esperienza di viaggio intensa e prolungata.

This semi-rigid rear bag mounts easily to the rear rack and is made of a perfect balance of leather and technical textile panels.

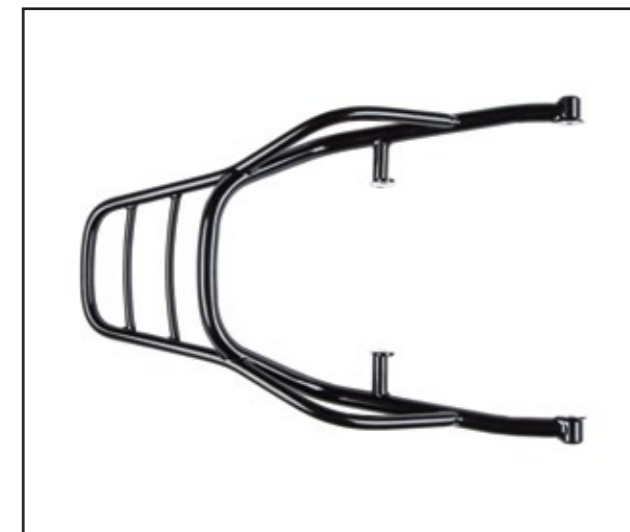

**PORTAPACCHI NERO
BLACK REAR RACK**

.....
COD. 2S000888

Il portapacchi posteriore, con finitura nera, è il supporto ideale per un bagaglio compatto o per il bauletto posteriore dedicato a V7.

This black rear rack improve the elegant shape of V7 and is needed to support the rear top box.



**PORTAPACCHI PICCOLO
VERNICIATO NERO
SMALL LUGGAGE RACK**

.....
COD. 2S000256

Un portapacchi di dimensioni ridotte in metallo verniciato nero. È pensato per agganciarci la borsa porta attrezzi, ma è perfetto anche per il tuo prossimo viaggio. Può essere montato solo con i codici 2S000152; 2S000147; 2S000180.

A small luggage rack in black painted metal. It is designed to attach the tool bag, but is also perfect for your next trip. Can be installed only with 2S000152; 2S000147; 2S000180.



GUZZI MULTIMEDIA PLATFORM

.....
COD. 606522M
COD. 2S000912 kit installazione / installation kit

MGMP è il nuovo dispositivo che consente di collegare il proprio Smartphone alla moto, trasformandola in una vera e propria piattaforma multimediale. Necessita del kit di installazione 2S000912.

MGMP is the new device that allows you to connect your smartphone to the motorcycle, turning it to a real multimedia platform. Needs installation kit 2S000912.



KIT INSTALLAZIONE PRESA USB
USB SOCKET INSTALLATION KIT

.....
 COD. 2S000983

Presse USB fornita di supporto dedicato per installazione nel sottosella, per la ricarica dei supporti elettronici, non consente il dialogo con gli apparati elettronici del mezzo.

USB socket with bracket for installation under the saddle, to recharge the electronic media, does not allow dialogue with the electronic devices of the vehicle.



ANTIFURTO ELETTRONICO
ANTITHEFT SYSTEM

.....
 COD. 606423M
 COD. 2S000978 kit installazione / installation kit

Protegge la tua moto grazie alla centralina compatta e tecnologicamente avanzata. Permette una facile e discreta installazione ed è dotata di telecomando. Il sistema è autoalimentato ed ha un assorbimento energetico minimo. Necessita kit di installazione.

This electronic antitheft system protect your vehicle. The electronic box is very small and packed with advanced technology, and allow an easy and invisible installation. This system has a battery backup and a very low power drain. Includes a remote control. need mounting kit.



TELO COPRIMOTO "SHAPE"
"SHAPE" BIKE COVER

.....
 COD. 606028M0002

Telo su misura da interno per la protezione dalla polvere da utilizzare durante le soste in garage della moto. È realizzato in un tessuto elasticizzato con grafica speciale.

Tailor-made motorcycle cover for inside use to protect against dust, intended for use during long periods of storing the bike in a garage. It is made of stretch fabric with special graphics.



TELO COPRIMOTO V7
V7 BIKE COVER

.....
 COD. 895729

Telo su misura da interno per la protezione dalla polvere da utilizzare durante le soste in garage della moto. È realizzato in un tessuto elasticizzato con grafica speciale.

Tailor-made motorcycle cover for inside use to protect against dust, intended for use during long periods of storing the bike in a garage. It is made of stretch fabric with special graphics.



TELO COPRIMOTO "EAGLE"
"EAGLE" BIKE COVER

.....
 COD. 606028M0001

Telo su misura da interno per la protezione dalla polvere da utilizzare durante le soste in garage della moto. È realizzato in un tessuto elasticizzato con grafica speciale.

Tailor-made motorcycle cover for inside use to protect against dust, intended for use during long periods of storing the bike in a garage. It is made of stretch fabric with special graphics.



V7 III

RACER

Per scoprire l'intera gamma Accessori di V7 III Racer
visita la nostra Rete di vendita Moto Guzzi

*For all info about V7 III Racer o Accessories line up,
visit your Moto Guzzi Dealer*



MOTO GUZZI®



MOTO GUZZI
V7 50
1967-2017

Per scoprire l'intera gamma Accessori di V7 50 Anniversario
visita la nostra Rete di vendita Moto Guzzi

*For all info about V7 50 Anniversary Accessories line up,
visit your Moto Guzzi Dealer*

V9

BOBBER

GUZZI



MOTO GUZZI®



**CUPOLINO BOBBER
BOBBER FLYSCREEN**

.....
COD. 2S000732

Disegnato appositamente per le linee decise della Bobber, permette di aumentare il comfort di viaggio grazie ad una migliore protezione aerodinamica. Omologato DOT e TUV.
This flyscreen is designed to work with the elegant Bobber shape, and gives better ride comfort thanks to better aerodynamic protection. Black mounting hardware. DOT & TUV homologated.



**COVER FARO ANTERIORE
CONTROL PANEL COVER - BOBBER**

.....
COD. 2B003374

Lo spirito Dark della tua V9 raggiunge l'apice con questo semplice dettaglio estetico che rende il frontale della tua moto ancora più forte e deciso.
The Dark Soul of V9 reach the top with this aesthetic detail that complete the strong and determined style of the front of Your motorcycle.



**CORNICE FARO NERA
BLACK HEADLAMP FRAME**

.....
COD. 2S000946

Lo spirito Dark della tua V9 raggiunge l'apice con questo semplice dettaglio estetico che rende il frontale della tua moto ancora più forte e deciso.
The Dark Soul of V9 reach the top with this aesthetic detail that complete the strong and determined style of the front of Your motorcycle.



**CORNICE FARO CROMATA
CHROMED HEADLAMP FRAME**

.....
COD. 2S000825

Copertura estetica e dal design moderno. Realizzata a taglio laser e piegata per armonizzarsi con il faro della moto. Logo Moto Guzzi.
Aesthetic Cover. Laser cutting and folding to be integrated with the head lamp. Moto Guzzi logo.



**LEVA FRIZIONE
FRONT CLUTCH LEVER**

.....
COD. 2S000925 Anodizzato Nero/Black Anodising
COD. 2S000815 Anodizzato Naturale/Natural Anodising

Realizzata in alluminio ricavato dal pieno, arricchisce la zona dei comandi a manubrio garantendo anche una maggiore sicurezza grazie alla possibilità di regolazione della distanza dalla manopola.

These adjustable billet aluminum levers dress up the V9 handlebar area and increase the safety level.



**LEVA FRENO
FRONT BRAKE LEVER**

.....
COD. 2S000924 Anodizzato Nero/Black Anodising
COD. 2S000814 Anodizzato Naturale/Natural Anodising

Realizzata in alluminio ricavato dal pieno, arricchisce la zona dei comandi a manubrio garantendo anche una maggiore sicurezza grazie alla possibilità di regolazione della distanza dalla manopola.

These adjustable billet aluminum levers dress up the V9 handlebar area and increase the safety level.



**PARAFANGO POSTERIORE NERO
BLACK REAR MUDGUARD**

.....
COD. 606630M

Completa il total look nero della tua V9 con questo parafango posteriore che si abbina perfettamente allo stile della moto.

Improve the Black soul total look of Your V9 with a dedicated rear mudguard in line with vehicle style.



**COVER PIASTRA INFERIORE
FORCELLA
FORK LOWER PLATE COVER**

.....
COD. 2S000826

Realizzata a taglio laser con apposite feritoie estetiche. Facile e veloce da montare. Logo Moto Guzzi.

Laser cutting and folding. Quick and easy to fit. Moto Guzzi logo.



**PIASTRA PARAFANGO ANTERIORE
FRONT FORK BRACE**

.....
COD. 2S000813

Realizzata in alluminio ricavato dal pieno, migliora notevolmente l'estetica dell'avantreno ed aumenta l'effetto anti-svirgolamento della forcella.

Made in billet aluminium. Premium CNC manufacture. It improves the quality of the design of the front part of the bike and increases the stability effect of the ride.



**PARAFANGO ANTERIORE NERO
BLACK FRON MUDGUARD**

.....
COD. 606631M

Completa il total look nero della tua V9 con questo parafango anteriore che si abbina perfettamente allo stile della moto.

Improve the Black soul total look of Your V9 with a dedicated front mudguard in line with vehicle style.



**SOFFIETTI FORCELLA
RUBBER FORK STANCHION
DUST BOOTS**

.....
COD. 606123M

Soffietto in gomma per dare uno stile ancora più muscoloso alla tua V9 e proteggere gli steli forcella dalla polvere e dai residui sulla strada. Il codice corrisponde ad un soffietto singolo: è necessario ordinare una coppia.

Rubber boot to protect the fork stanchions on your V9 from dust, road residue and anything else you may encounter on your adventures. The code corresponds to one dust boot: two pieces must be ordered.



**COPPIA COVER VITI TELAIO
ANTERIORE
FRAME SCREWS COVER**

.....
COD. 2S000929 Anodizzato Nero/Black Anodising
COD. 2B003375 Anodizzato Naturale/Natural Anodising

Realizzate in alluminio ricavato dal pieno trasformano la zona di congiuntura del telaio in un elemento estetico originale e prezioso.

These billet aluminum frame screw covers transform the V9 frame connection area.



**FIANCHETTI SOTTOSELLA NERI
BLACK UNDERSEAT PANNELLS**

.....
COD. 2S000895

Fianchetto in alluminio verniciato nero, completa lo stile dark soul del veicolo.

Side panels in black color to complete Dark Soul look of the vehicle.



**FIANCHETTI SOTTOSELLA SATINATI
SATIN UNDERSEAT PANNELLS**

.....
COD. 2S000890

Fianchetto in alluminio satinato, impreziosisce la parte centrale di V9 con materiali e finiture premium.

Satin aluminium side panels give the central body of the vehicle a precious look with premium materials and finishing.

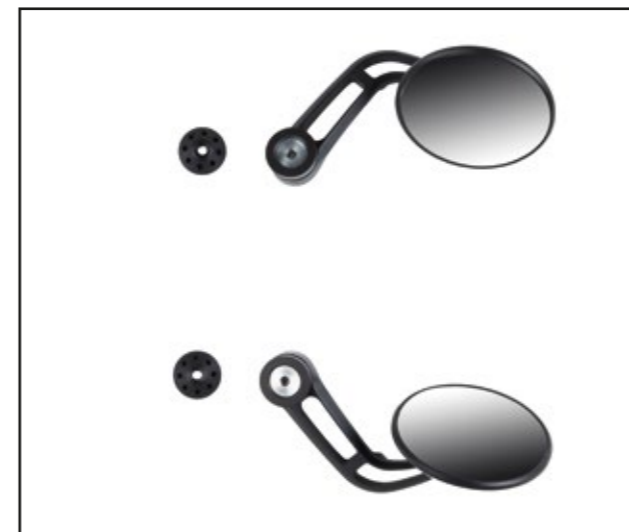

**COPPIA SPECCHI RETROVISORI
ESTERNI
EXTERNAL REAR MIRRORS**

.....
COD. 2S000923 Anodizzato Nero/Black Anodising
COD. 2B003373 Anodizzato Naturale/Natural Anodising

Realizzati in alluminio ricavati dal pieno, arricchiscono la zona dei comandi a manubrio con una linea elegante, un montaggio originale e un'ampia possibilità di regolazione.

These billet aluminum adjustable bar end mirrors dress up the V9 handlebars thanks to an elegant shape and offer a wide possibility of adjustments.



**COPRIFILETTO SPECCHI ORIGINALI
MIRROR HOLDER HOLE COVERS**

.....
COD. 2S000926 Anodizzato Nero/Black Anodising
COD. 2S000807 Anodizzato Naturale/Natural Anodising

Realizzati in alluminio ricavato dal pieno arricchiscono la zona dei comandi a manubrio coprendo gli alloggiamenti del gambo specchietto con un veri e propri gioielli. Si abbinano perfettamente agli specchi a manubrio 2S000923.

These V9 mirror hole blockoff plates are made of billet aluminum to dress up the handlebar area. These covers are the for those owners who have switched out to the bar end mirrors 2S000923.



**COVER POMPA FRENO ANTERIORE
FRONT BRAKE RESERVOIR COVER**

.....
COD. 2S000927 Anodizzato Nero/Black Anodising
COD. 2S000817 Anodizzato Naturale/Natural Anodising

Realizzata in alluminio ricavata dal pieno arricchisce la zona dei comandi a manubrio e può essere montata facilmente senza aprire il serbatoio.

This premium reservoir cover is made of billet aluminum and dresses up the V9 handlebar controls and can be easily mounted without opening the reservoir.



**COPPIA MANOPOLE IN ALLUMINIO
ALUMINIUM HANDGRIPS**

.....
COD. 2S000935 Anodizzato Nero/Black Anodising
COD. 2S000810 Anodizzato Naturale/Natural Anodising

In alluminio ricavato dal pieno arricchiscono la zona dei comandi a manubrio e permettono una presa sicura e confortevole.

These handgrips are made of billet aluminum with rubber inserts, dress up the V9 cockpit and improve the safety and comfort.



**COPPIA COVER TAPPI FORCELLA
FORK TOP CAPS COVER**

.....
COD. 2S000928 Anodizzato Nero/Black Anodising
COD. 2B003377 Anodizzato Naturale/Natural Anodising

Realizzati in alluminio ricavato dal pieno arricchiscono il ponte di comando donando alla piastra forcella un look elegante e prezioso.

These fork cap covers are made of billet aluminum and dress up the V9 fork top plate.



**SERBATOIO NERO
BLACK TANK**

.....
COD. 606471M

Lo stile Dark Soul può risultare completo solo utilizzando il serbatoio completamente nero, che rispecchia il carattere e la forza della tua Moto Guzzi.

Only with this total black tank You can complete the Dark Soul style, reflecting the strength and determination of your Moto Guzzi.



**COVER REGOLATORE DI TENSIONE CON COVER CLAXON
VOLTAGE REGULATOR AND HORN COVER**

.....
COD. 2S000808

Realizzato in alluminio ricavato dal pieno, in versione satinata, risalta la linea filante e snella della moto con una finitura ricca ed elegante.

This voltage regulator and horn cover is made of billet aluminum with satin treatment and gives a rich and elegant finishing highlighting the slim and sinuous shape of the V9.



**TAPPO CARBURANTE CON SERRATURA
TANK CAP WITH KEY LOCK**

.....
COD. 2S000934 Anodizzato Nero/Black Anodising
COD. 2S000772 Anodizzato Naturale/Natural Anodising

Realizzato in alluminio ricavato dal pieno, arricchisce il design del sinuoso serbatoio di Bobber, garantendo maggiore sicurezza grazie alla serratura anti-apertura.

This billet aluminum locking gas cap gives peace of mind and dresses up the V9 tank design. Comes with two keys.



**PROTEZIONI COPERCHIO TESTA
CYLINDER PROTECTIONS KITS**

.....
COD. 2S000930 Anodizzato Nero/Black Anodising
COD. 2B003379 Anodizzato Naturale/Natural Anodising

Realizzati in alluminio ricavati dal pieno, proteggono la parte alta del motore donando un tocco di eleganza ed esclusività alla moto.

These cylinder head protection kits are made of billet aluminum, protect the cylinder heads and enhance the black total look of V9 Bobber.



**COVER GHIERE COLLETTORI DI SCARICO
EXHAUST TUBES RING BOLT COVERS**

.....
COD. 2B003381

Finiture estetiche in acciaio tagliato al laser, permettono di abbellire la parte frontale degli scarichi con un tocco di eleganza ed originalità.

Exhaust flange accent cover made of laser cut steel, adds some extra elegance and originality to the exhaust flange of your V9.

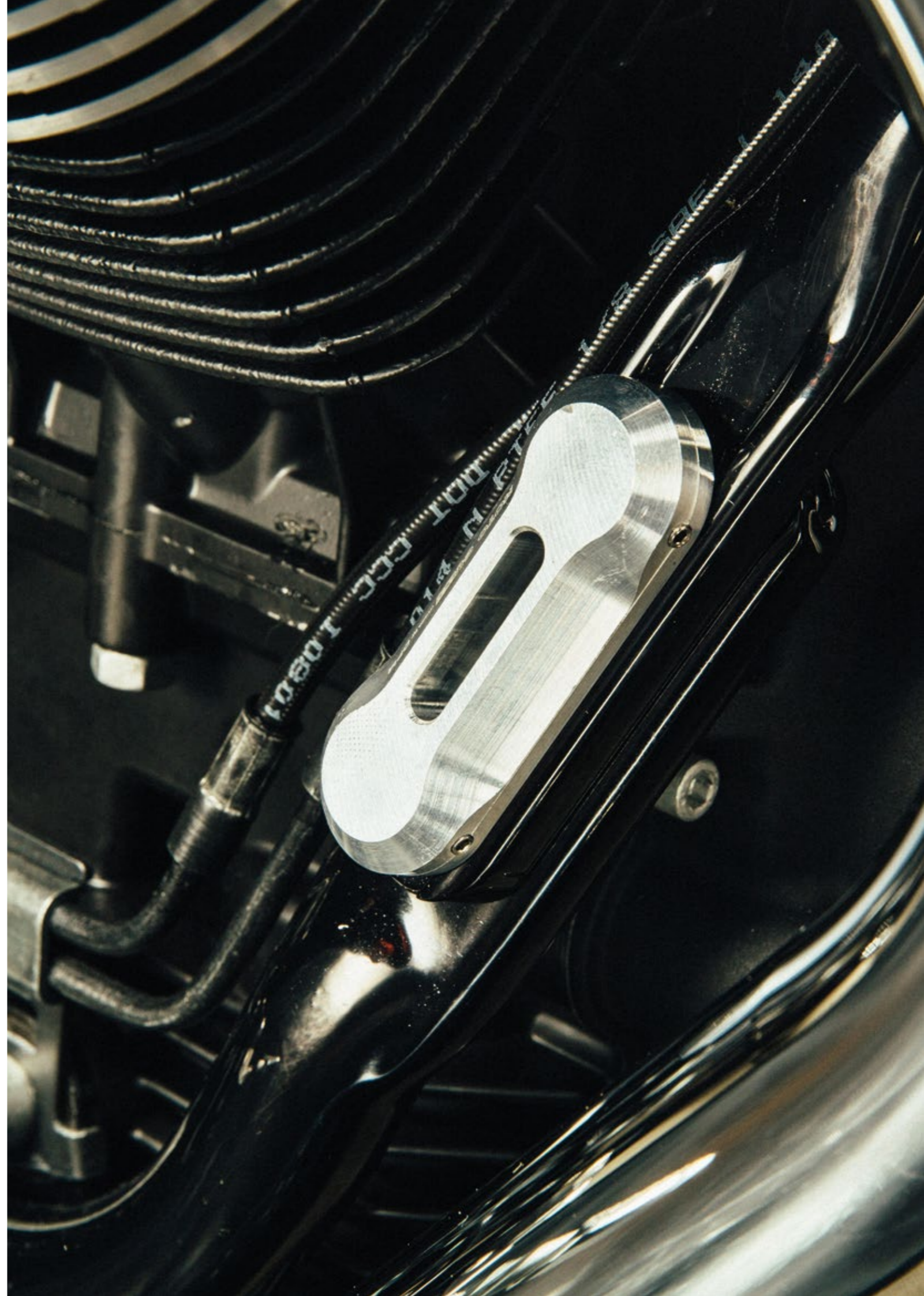



SCARICO SLIP ON OMOLOGATO BOBBER
EXHAUST HOMOLOGATED BOBBER SLIP ON

.....
 COD. 2B003370

Lo scarico Bobber è verniciato in una aggressiva tonalità nera opaca che accentua il sound dell'inconfondibile bicilindrico di Mandello. La parte finale dello scarico è rifinita in alluminio con una sagomatura obliqua, decisa e moderna. This Bobber slip-on exhaust system is painted in an aggressive matt black and enhances the sound of the unmistakable twin made in Mandello. Slash-cut tips and removable noise tube (for closed course use only with noise tube removed).



BENDE SCARICHI NERE
BANDAGES TAPES BLACK

.....
 COD. 605993M
 COD. 606014M RAME / COPPER

Le bende scarico sono il complemento ideale allo scarico Bobber ed accentuano ulteriormente lo stile aggressivo e prestazionale della moto. This header wrap is the perfect companion for the Bobber exhaust system, improving the aggressive and performance look of the vehicle.



COPPIA COVER PEDANE POGGIAPIEDI PILOTA
BLACK FOOTPEGS COVER

.....
 COD. 2S000933 Anodizzato Nero/Black Anodising
 COD. 2B003376 Anodizzato Naturale/Natural Anodising

In prezioso alluminio ricavato dal pieno garantiscono alle pedane un aspetto più aggressivo, con una fresatura ordinata ed efficace. Billet footpeg covers made of billet aluminum, with a total black look enhance the aggressive style thanks to its grippy knurled surface.



COPPIA COVER PEDANE POGGIA PIEDI PASSEGGERO
PASSENGER FOOTPEGS COVER

.....
 COD. 2S000809

in prezioso alluminio ricavato dal pieno garantiscono alle pedane un aspetto più elegante, e garantiscono un appoggio stabile e sicuro grazie ad una fresatura ordinata ed efficace. Billet footpeg covers made of billet aluminum, with a nicer, more elegant look and a more stable and safe contact with the V9 during riding, thanks to its grippy knurled surface.



COVER POMPA FRENO POSTERIORE
REAR BRAKE RESERVOIR COVER

.....
 COD. 2S000931 Anodizzato Nero/Black Anodising
 COD. 2S000818 Anodizzato Naturale/Natural Anodising

Realizzata in alluminio ricavata dal pieno arricchisce la zona della pompa freno posteriore con un gioiello brillante e prezioso. Rear brake reservoir cover made of billet aluminum, dresses up the side of the V9.



PROTEZIONE POMPA FRENO POSTERIORE
REAR BRAKE PROTECTION

.....
 COD. 2B003378

In alluminio con finitura nera, abbraccia e protegge la zona della pompa freno posteriore con eleganza e stile. Rear Brake Protection Kit made of billet aluminum with black finishing, embraces and protects the rear brake pump of your V9 with elegance and style.

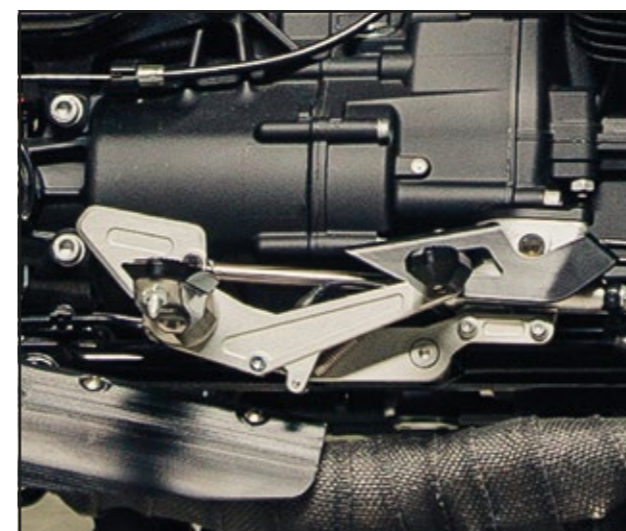

PEDANE ARRETRATE
REARSET FOOTPEGS

.....
 COD. 2S001054 - MY16

Il kit pedane arretrate offre una diversa impostazione di guida ed ergonomia in modo da rendere la tua Moto Guzzi ideale alle tue esigenze e al tuo stile. Per modelli fino al 2016. This kit gives a different ergonomic and ride positioning, to let your Moto Guzzi fit exactly your needs and style. For MY16 only.



PEDALINO FRENO POSTERIORE
BRAKE LEVER PAD

.....
 COD. 2S000932 Anodizzato Nero/Black Anodising
 COD. 2S000812 Anodizzato Naturale/Natural Anodising

Il pedalino, realizzato in alluminio ricavato dal pieno, permette un più solido e sicuro azionamento del pedale del freno garantendo allo stesso tempo un design ed un impatto estetico più prezioso ed importante. Extra wide brake lever peg made of billet aluminum, increase safety when using the rear brake lever and at the same time enhances design and richness of the V9.

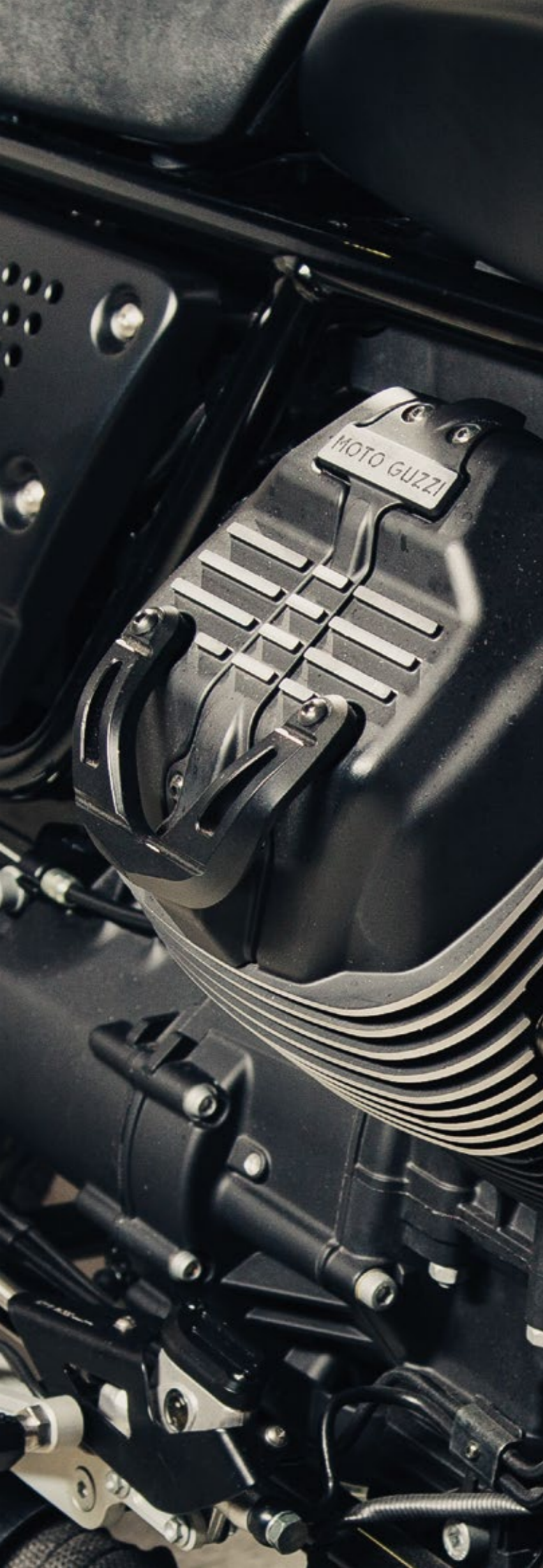

**COVER AMMORTIZZATORI POSTERIORI
REAR SHOCK ABSORBER COVERS**

COD. 2S000811

Realizzate in alluminio ricavato dal pieno, queste cover rendono ancora più preziosa la parte posteriore di Bobber, sottolineando l'utilizzo di materiali di pregio per i componenti, che rendono l'estetica del veicolo più filante ma allo stesso tempo più ricca ed appariscente.

These billet aluminum rear shock absorber covers dress up the rear part of Bobber. Not compatible with the sidebag mounting racks or luggage rack.

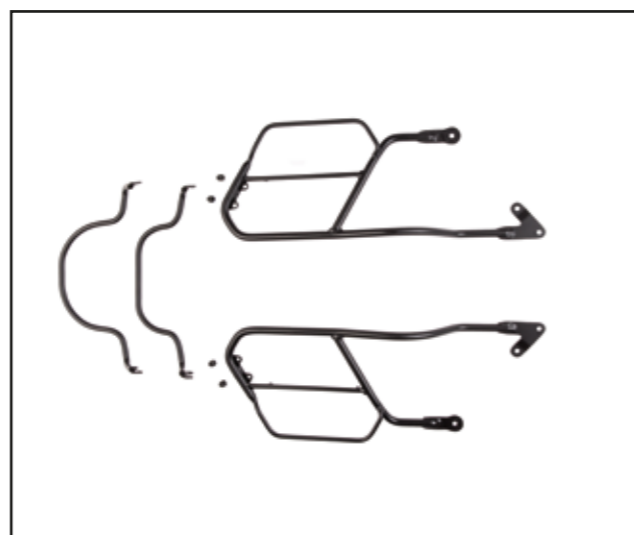

**TELAIETTI PER VALIGIE LATERALI
SIDE BAGS SUPPORT**

COD. 2S000723

Questi supporti, dalla linea snella ed armoniosa, in un'elegante verniciatura nera, mantengono invariato il look del veicolo, e consentono di utilizzare tutte le borse laterali a sgancio rapido dedicate a V9.

These sidebag supports were developed in conjunction with the V9 and are necessary to mount the sidebags. Black finish, streamlined and styled with the bike. These maintain the vehicle's looks and allow the use of all Moto Guzzi quick release side bags dedicated to V9.



**SELLA PILOTA "LOW RIDE"
"LOW RIDE" RIDER SEAT**

COD. 2S000737

La sella monoposto per pilota dona un aspetto più sportivo e ricco ottimizzando il comfort di seduta grazie ad una speciale imbottitura che permette esperienze di guida più lunghe e piacevoli.

The rider comfort saddle gives a richer, sportier look to the vehicle and at the same time increase comfort thanks to a specific compound that improves riding comfort.



**SELLINO PASSEGGERO "LOW RIDE"
"LOW RIDE" PASSENGER SEAT**

COD. 2S000738

La sella passeggero permette di vivere emozioni di viaggio in coppia donando un aspetto più importante alla linea della moto ed ottimizzando il comfort di seduta, grazie ad una speciale imbottitura che permette esperienze di guida più lunghe e piacevoli.

The passenger comfort saddle gives a richer, sportier look to the vehicle and at the same time increase comfort thanks to a specific compound that improves riding comfort.



**BORSE CANVAS
CANVAS SIDE BAGS**

COD. 2S000907

In pregiato tessuto e rifiniture in pelle, queste borse morbide si applicano facilmente e velocemente agli appositi supporti grazie agli attacchi Fast Click. Necessitano del kit montaggio 2S000723.

In precious fabric and leather finishing, these bags can be easily and quickly applied on the vehicle thanks to Fast Click release system. Needs mounting support 2S000723.



**COPPIA BORSE PELLE PREMIUM
PREMIUM LEATHER SIDE BAGS**

COD. 2S000522

Pelle di prima scelta, cura dei dettagli ed una finitura che rispecchia la concia artigianale delle pelletterie italiane. Sono dotate di uno sgancio rapido e di sistema di sicurezza antifurto che ne permettono un comodo utilizzo, dal quotidiano al viaggio. Necessitano degli appositi supporti 2S000723.

These quick release side bags are made of made of premium Italian leather, are equipped with a quick release and safe locking system, useful on everything from daily trips to long trips. Comes with carrying strap. Installation requires mounting support 2S000723 for all V9.



**COPRISERBATOIO CON BORSA
TANK COVER WITH
TANK SEMIRIGID BAG**

.....
COD. 2S000729

In pelle di prima scelta, questa preziosa combinazione di copri serbatoio e borsa permette di aumentare notevolmente la capacità di carico, integrandosi perfettamente nella linea di Roamer e permettendo lunghe percorrenze in pieno comfort di guida.

Tankbag and tank cover made of premium leather, this kit considerably increases the luggage capacity, perfectly matching the Roamer shape and allowing long rides in full comfort.



**BORSA BAULETTO IN TESSUTO
TECNICO BOBBER
BOBBER REAR BAG**

.....
COD. 2B003369

Realizzata con una perfetta combinazione tra pelle e tessuto tencico, permette di alloggiare sul portapacchi posteriore un bagaglio sufficiente a vivere un'esperienza di viaggio intensa e prolungata.

This Bobber semi-rigid rear bag mounts easily to the rear rack and is made of a perfect balance of leather and technical textile panels.



**ANTIFURTO ELETTRONICO
ANTITHEFT SYSTEM**

.....
COD. 606423M
COD. 2S000758 kit installazione / installation kit

Protegge la tua V9 grazie alla centralina compatta e tecnologicamente avanzata. Permette una facile e discreta installazione ed è dotata di telecomando. Il sistema è autoalimentato ed ha un assorbimento energetico minimo. Necessita dell'apposito kit di installazione 2S000758 (a parte).

This electronic antitheft system protect your V9. The electronic box is very small and packed with advanced technology, and allow an easy and invisible installation. This system has a battery backup and a very low power drain. Includes a remote control. It needs installation kit 2S000758.



GUZZI MULTIMEDIA PLATFORM

.....
COD. 606408M
COD. 2S000759 kit installazione / installation kit

MGMP è il nuovo dispositivo che consente di collegare il proprio Smartphone alla moto, trasformandola in una vera e propria piattaforma multimediale. Necessita del kit di installazione 2S000759.

MGMP is the new device that allows you to connect your smartphone to the motorcycle, turning it to a real multimedia platform. Needs installation kit 2S000759.



**COPPIA BORSE LATERALI TOURING
CON SGANCIO RAPIDO
TOURING SIDE BAGS**

.....
COD. 2S000731

Le borse laterali da turismo, in tessuto tecnico, hanno robustezza e capienza che la rendono indispensabile per intraprendere lunghi viaggi. Dotate di sgancio rapido e sistema di sicurezza antifurto che ne permettono un comodo utilizzo. Necessitano degli appositi supporti 2S000723.

These quick release side bags are made of made of cordura with leather inserts, are weather resistant and are equipped with a quick release and safe locking system, useful on everything from daily trips to long trips. Comes with carrying strap. Installation requires mounting support 2S000723 for all Roamer.



**PORTAPACCHI NERO BOBBER
BLACK REAR RACK BOBBER**

.....
COD. 2S000724*
*compatibile con sella Pilota e passeggero Low Ride
*compatible with Low Ride saddles

Il portapacchi posteriore, con finitura nera, è il supporto ideale per un bagaglio compatto o per il bauletto posteriore dedicato a V9.

This black rear rack improve the elegant shape of V9 and is needed to support the rear top box.

V9

ROAMER





**CUPOLINO ROAMER
ROAMER FLYSCREEN**

.....
COD. 2S000733

Disegnato appositamente per le eleganti linee della Roamer, permette di aumentare il comfort di viaggio grazie ad una migliore protezione aerodinamica. Omologato DOT e TUV.

This flyscreen is designed to work with the elegant Roamer shape, and gives better ride comfort thanks to better aerodynamic protection. Chrome mounting hardware. DOT & TUV homologated.



**PARABREZZA TOURING
TOURING WINDSCREEN**

.....
COD. 2S001042

Parabrezza con la lastra in Lexan antiurto e antigraffio, sicuro ed avvolgente per un massimo comfort di viaggio, che mantiene nel tempo inalterate le caratteristiche di trasparenza e lucentezza.

Touring sized windshield with shockproof and scratch resistant Lexan sheet, stable and aerodynamic for a perfect riding comfort, maintaining the transparency and gloss characteristics unaltered over time.



**COVER PIASTRA INFERIORE
FORCELLA
FORK LOWER PLATE COVER**

.....
COD. 2S000826

Realizzata a taglio laser con apposite feritoie estetiche. Facile e veloce da montare. Logo Moto Guzzi.

Laser cutting and folding. Quick and easy to fit. Moto Guzzi logo.



**COVER RISER ROAMER
HANDLEBAR RISER COVER**

.....
COD. 2B003380

Realizzati in alluminio ricavati dal pieno arricchiscono il ponte di comando e permettono una posizione di guida ancora più rilassata.

These billet aluminum riser caps dress up the Roamer handlebar area. Sold as a pair.



**CORNICE FARO CROMATA
CHROMED HEADLAMP FRAME**

.....
COD. 2S000825

Copertura estetica e dal design moderno. Realizzata a taglio laser e piegata per armonizzarsi con il faro della moto. Logo Moto Guzzi.

Aesthetic Cover. Laser cutting and folding to be integrated with the head lamp. Moto Guzzi logo.



**PIASTRA PARAFANGO ANTERIORE
FRONT FORK BRACE**

.....
COD. 2S000813

Realizzata in alluminio ricavato dal pieno, migliora notevolmente l'estetica dell'avantreno ed aumenta l'effetto anti-svirgolamento della forcella.

Made in billet aluminium. Premium CNC manufacture. It improves the quality of the design of the front part of the bike and increases the stability effect of the ride.



**SOFFIETTI FORCELLA
RUBBER FORK STANCHION
DUST BOOTS**

.....
COD. 636123M

Soffietto in gomma per dare uno stile ancora più muscoloso alla tua V9 e proteggere gli steli forcella dalla polvere e dai residui sulla strada. Il codice corrisponde ad un soffietto singolo: è necessario ordinare una coppia.

Rubber boot to protect the fork stanchions on your V9 from dust, road residue and anything else you may encounter on your adventures. The code corresponds to one dust boot: two pieces must be ordered.



**COVER POMPA FRENO ANTERIORE
FRONT BRAKE RESERVOIR COVER**

.....
COD. 2S000817 Anodizzato Naturale/Natural Anodising
COD. 2S000927 Anodizzato Nero/Black Anodising

Realizzata in alluminio ricavata dal pieno arricchisce la zona dei comandi a manubrio e può essere montata facilmente senza aprire il serbatoio.

This premium reservoir cover is made of billet aluminum and dresses up the V9 handlebar controls and can be easily mounted without opening the reservoir.



**LEVA FRIZIONE
FRONT CLUTCH LEVER**

.....
COD. 2S000815 Anodizzato Naturale/Natural Anodising
COD. 2S000925 Anodizzato Nero/Black Anodising

Realizzata in alluminio ricavato dal pieno, arricchisce la zona dei comandi a manubrio garantendo anche una maggiore sicurezza grazie alla possibilità di regolazione della distanza dalla manopola.

These adjustable billet aluminum levers dress up the V9 handlebar area and increase the safety level.



**LEVA FRENO ANTERIORE
FRONT BRAKE LEVER**

.....
COD. 2S000814 Anodizzato Naturale/Natural Anodising
COD. 2S000924 Anodizzato Nero/Black Anodising

Realizzata in alluminio ricavato dal pieno, arricchisce la zona dei comandi a manubrio garantendo anche una maggiore sicurezza grazie alla possibilità di regolazione della distanza dalla manopola.

These adjustable billet aluminum levers dress up the V9 handlebar area and increase the safety level.



**COPRIFILETTO SPECCHI ORIGINALI
MIRROR HOLDER HOLE COVERS**

.....
COD. 2S000807 Anodizzato Naturale/Natural Anodising
COD. 2S000926 Anodizzato Nero/Black Anodising

Realizzati in alluminio ricavato dal pieno arricchiscono la zona dei comandi a manubrio coprendo gli alloggiamenti del gambo specchietto con un veri e propri gioielli. Si abbinano perfettamente agli specchi a manubrio 2B003373.

These V9 mirror hole blockoff plates are made of billet aluminum to dress up the handlebar area. These covers are the for those owners who have switched out to the bar end mirrors 2B003373.



**COPPIA COVER TAPPI FORCELLA
FORK TOP CAPS COVER**

.....
COD. 2B003377 Anodizzato Naturale/Natural Anodising
COD. 2S000928 Anodizzato Nero/Black Anodising

Realizzati in alluminio ricavato dal pieno arricchiscono il ponte di comando donando alla piastra forcella un look elegante e prezioso.

These fork cap covers are made of billet aluminum and dress up the V9 fork top plate.



**COPPIA SPECCHI
RETROVISORI ESTERNI
EXTERNAL REAR MIRRORS**

.....
COD. 2B003373 Anodizzato Naturale/Natural Anodising
COD. 2S000923 Anodizzato Nero/Black Anodising

Realizzati in alluminio ricavati dal pieno, arricchiscono la zona dei comandi a manubrio con una linea elegante, un montaggio originale e un'ampia possibilità di regolazione.

These billet aluminum adjustable bar end mirrors dress up the V9 handlebars thanks to an elegant shape and offer a wide possibility of adjustments.



**COPPIA MANOPOLE IN ALLUMINIO
ALUMINIUM HANDGRIPS**

.....
COD. 2S000810 Anodizzato Naturale/Natural Anodising
COD. 2S000935 Anodizzato Nero/Black Anodising

In alluminio ricavato dal pieno arricchiscono la zona dei comandi a manubrio e permettono una presa sicura e confortevole.

These handgrips are made of billet aluminum with rubber inserts, dress up the V9 cockpit and improve the safety and comfort.



**COPPIA COVER VITI TELAIO
ANTERIORE
FRAME SCREWS COVER**

.....
COD. 2B003375 Anodizzato Naturale/Natural Anodising
COD. 2S000929 Anodizzato Nero/Black Anodising

Realizzate in alluminio ricavato dal pieno trasformano la zona di congiuntura del telaio in un elemento estetico originale e prezioso.

These billet aluminum frame screw covers transform the V9 frame connection area.



**TAPPO CARBURANTE
CON SERRATURA
TANK CUP WITH KEY LOCK**

.....
COD. 2S000772 Anodizzato Naturale/Natural Anodising
COD. 2S000934 Anodizzato Nero/Black Anodising

Realizzato in alluminio ricavato dal pieno, arricchisce il design del sinuoso serbatoio di Roamer, garantendo maggiore sicurezza grazie alla serratura anti-apertura.

This billet aluminum locking gas cap gives peace of mind and dresses up the V9 tank design. Comes with two keys.



**PROTEZIONI
COPERCHIO TESTA
CYLINDER PROTECTIONS KITS**

.....
 COD. 2B003379 Anodizzato Naturale/Natural Anodising
 COD. 2S000930 Anodizzato Nero/Black Anodising

Realizzati in alluminio ricavati dal pieno, proteggono la parte alta del motore donando un tocco di eleganza ed esclusività alla moto.

These cylinder head protection kits are made of billet aluminum, protect the cylinder heads and adds an elegant and exclusive touch to the V9 shape.



**COVER GHIERE COLLETTORI
DI SCARICO
EXHAUST TUBES RING BOLT
COVERS**

.....
 COD. 2B003381

Finiture estetiche in acciaio tagliato al laser, permettono di abbellire la parte frontale degli scarichi con un tocco di eleganza ed originalità.

Exhaust flange accent cover made of laser cut steel, adds some extra elegance and originality to the exhaust flange of your V9.



**COVER POMPA FRENO POSTERIORE
REAR BRAKE RESERVOIR COVER**

.....
 COD. 2S000818 Anodizzato Naturale/Natural Anodising
 COD. 2S000931 Anodizzato Nero/Black Anodising

Realizzata in alluminio ricavata dal pieno arricchisce la zona della pompa freno posteriore con un gioiello brillante e prezioso.

Rear brake reservoir cover made of billet aluminum, dresses up the side of the V9.



**PEDALINO FRENO
BRAKE LEVER PAD**

.....
 COD. 2S000812 Anodizzato Naturale/Natural Anodising
 COD. 2S000932 Anodizzato Nero/Black Anodising

Il pedalino, realizzato in alluminio ricavato dal pieno, permette un più solido e sicuro azionamento del pedale del freno garantendo allo stesso tempo un design ed un impatto estetico più prezioso ed importante.

Extra wide brake lever peg made of billet aluminum, increase safety when using the rear brake lever and at the same time enhances design and richness of the V9.



**PROTEZIONE POMPA FRENO POSTERIORE
REAR BRAKE PROTECTION KIT**

COD. 2B003378

In alluminio con finitura nera, abbraccia e protegge la zona della pompa freno posteriore con eleganza e stile.

Rear Brake Protection Kit made of billet aluminum with black finishing, embraces and protects the rear brake pump of your V9 with elegance and style.

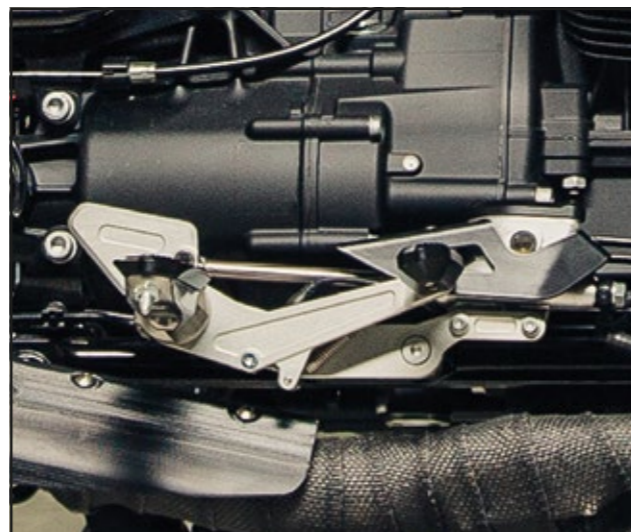

**PEDANE ARRETRATE
REARSET FOOTPEGS**

.....
COD. 2S001054 - MY16

Il kit pedane arretrate offre una diversa impostazione di guida ed ergonomia in modo da rendere la tua Moto Guzzi ideale alle tue esigenze e al tuo stile. Per modelli fino al 2016.

This kit gives a different ergonomic and ride positioning, to let your Moto Guzzi fit exactly your needs and style. For MY16 only.



**COVER REGOLATORE DI TENSIONE CON COVER CLAXON
VOLTAGE REGULATOR AND HORN COVER**

.....
COD. 2S000808

Realizzato in alluminio ricavato dal pieno, in versione satinata, risalta la linea filante e snella della moto con una finitura ricca ed elegante.

This voltage regulator and horn cover is made of billet aluminum with satin treatment and gives a rich and elegant finishing highlighting the slim and sinuous shape of the V9.



**SELLA COMFORT
COMFORT SADDLE**

.....
COD. 2S001044

Godi appieno il piacere di guida utilizzando questa sella dalla finitura esterna di pregio e dal morbido supporto alla seduta. La sensazione di guida Moto Guzzi sarà piena anche nelle lunghe percorrenze.

This saddle enhance the riding pleasure thanks to an incredible finishing and a soft seat compound. You will have a full Moto Guzzi experience also on long distance ride



**COPPIA COVER PEDANE
POGGIAPIEDI PILOTA
FOOTPEGS COVER**

.....
COD. 2B003376 Anodizzato Naturale/Natural Anodising
COD. 2S000933 Anodizzato Nero/Black Anodising

In prezioso alluminio ricavato dal pieno garantiscono alle pedane un aspetto più elegante, e garantiscono un appoggio stabile e sicuro grazie ad una fresatura ordinata ed efficace.

Billet footpeg covers made of billet aluminum, with a nicer, more elegant look and a more stable and safe contact with the V9 during riding, thanks to its grippy knurled surface.



**COPPIA COVER PEDANE
POGGIA PIEDI PASSEGGERO
PASSENGER FOOTPEGS
COVER**

.....
COD. 2S000809

In prezioso alluminio ricavato dal pieno garantiscono alle pedane un aspetto più elegante, e garantiscono un appoggio stabile e sicuro grazie ad una fresatura ordinata ed efficace.

Billet footpeg covers made of billet aluminum, with a nicer, more elegant look and a more stable and safe contact with the V9 during riding, thanks to its grippy knurled surface.



**SELLA PILOTA "LOW RIDE"
"LOW RIDE" RIDER SEAT**

.....
COD. 2S000737

La sella monoposto per pilota dona un aspetto più sportivo e ricco ottimizzando il comfort di seduta grazie ad una speciale imbottitura che permette esperienze di guida più lunghe e piacevoli.

The rider comfort saddle gives a richer, sportier look to the vehicle and at the same time increase comfort thanks to a specific compound that improves riding comfort.



**SELLINO PASSEGGERO "LOW RIDE"
"LOW RIDE" PASSENGER SEAT**

.....
COD. 2S000738

La sella passeggero permette di vivere emozioni di viaggio in coppia donando un aspetto più importante alla linea della moto ed ottimizzando il comfort di seduta, grazie ad una speciale imbottitura che permette esperienze di guida più lunghe e piacevoli.

The passenger comfort saddle gives a richer, sportier look to the vehicle and at the same time increase comfort thanks to a specific compound that improves riding comfort.

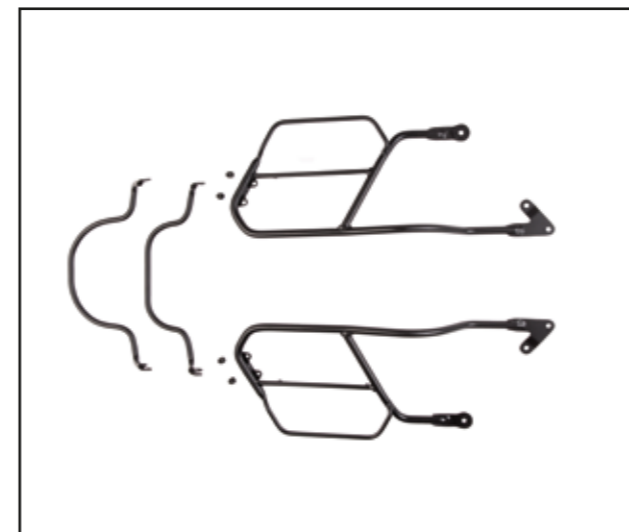

**TELAJETTI PER VALIGIE LATERALI
SIDE BAGS SUPPORT**

.....
COD. 2S000723

Questi supporti, dalla linea snella ed armoniosa, in un'elegante verniciatura nera, mantengono invariato il look del veicolo, e consentono di utilizzare tutte le borse laterali a sgancio rapido dedicate a V9.

These sidebag supports were developed in conjunction with the V9 and are necessary to mount the sidebags. Black finish, streamlined and styled with the bike. These maintain the vehicle's looks and allow the use of all Moto Guzzi quick release side bags dedicated to V9.



**COPPIA BORSE PELLE PREMIUM
PREMIUM LEATHER SIDE BAGS**

.....
COD. 2S000522

Pelle di prima scelta, cura dei dettagli ed una finitura che rispecchia la concia artigianale delle pelletterie italiane. Sono dotate di uno sgancio rapido e di sistema di sicurezza antifurto che ne permettono un comodo utilizzo, dal quotidiano al viaggio. Necessitano degli appositi supporti 2S000723.

These quick release side bags are made of made of premium Italian leather, are equipped with a quick release and safe locking system, useful on everything from daily trips to long trips. Comes with carrying strap. Installation requires mounting support 2S000723 for all V9.



**BORSE CANVAS
CANVAS SIDE BAGS**

.....
COD. 2S000907

In pregiato tessuto e rifiniture in pelle, queste borse morbide si applicano facilmente e velocemente agli appositi supporti grazie agli attacchi Fast Click. Necessitano del kit montaggio 2S000723.

In precious fabric and leather finishing, these bags can be easily and quickly applied on the vehicle thanks to Fast Click release system. Needs mounting support 2S000723.



**COPPIA BORSE LATERALI TOURING
CON SGANCIO RAPIDO
TOURING SIDE BAGS**

.....
COD. 2S000731

Le borse laterali da turismo, in tessuto tecnico, hanno robustezza e capienza che la rendono indispensabile per intraprendere lunghi viaggi. Dotate di sgancio rapido e sistema di sicurezza antifurto che ne permettono un comodo utilizzo. Necessitano degli appositi supporti 2S000723.

These quick release side bags are made of made of cordura with leather inserts, are weather resistant and are equipped with a quick release and safe locking system, useful on everything from daily trips to long trips. Comes with carrying strap. Installation requires mounting support 2S000723 for all Roamer.



**COPRISERBATOIO CON BORSA
TANK COVER WITH
TANK SEMIRIGID BAG**

.....
COD. 2S000729

In pelle di prima scelta, questa preziosa combinazione di copri serbatoio e borsa permette di aumentare notevolmente la capacità di carico, integrandosi perfettamente nella linea di Roamer e permettendo lunghe percorrenze in pieno comfort di guida.

Tankbag and tank cover made of premium leather, this kit considerably increases the luggage capacity, perfectly matching the Roamer shape and allowing long rides in full comfort.



**PORTAPACCHI NERO ROAMER
BLACK REAR RACK ROAMER**

.....
COD. 2S000819*

*compatibile con sella Pilota Solo o passeggero Lowride
*compatible with Solo and Low Ride saddles

Il portapacchi posteriore, con finitura nera, è il supporto ideale per un bagaglio compatto o per il bauletto posteriore dedicato a Roamer.

This black rear rack improve the elegant shape of Roamer and is needed to support the rear top box.



**ANTIFURTO ELETTRONICO
ANTITHEFT SYSTEM**

.....
COD. 606423M

COD. 2S000758 kit installazione / installation kit

Protegge la tua V9 grazie alla centralina compatta e tecnologicamente avanzata. Permette una facile e discreta installazione ed è dotata di telecomando. Il sistema è autoalimentato ed ha un assorbimento energetico minimo.

This electronic antitheft system protect your V9. The electronic box is very small and packed with advanced technology, and allow an easy and invisible installation. This system has a battery backup and a very low power drain. Includes a remote control.



**BORSA BAULETTO SEMIRIGIDA
MISTO PELLE-TEX ROAMER
ROAMER REAR BAG**

.....
COD. 2B003372

Realizzata con una perfetta combinazione tra pelle e tessuto tencico, permette di alloggiare sul portapacchi posteriore un bagaglio sufficiente a vivere un'esperienza di viaggio intensa e prolungata.

This Roamer semi-rigid rear bag mounts easily to the rear rack and is made of a perfect balance of leather and technical textile panels.



GUZZI MULTIMEDIA PLATFORM

.....
COD. 606408M

COD. 2S000759 kit installazione / installation kit

MGMP è il nuovo dispositivo che consente di collegare il proprio Smartphone alla moto, trasformandola in una vera e propria piattaforma multimediale. Necessita del kit di installazione 2S000759.

MGMP is the new device that allows you to connect your smartphone to the motorcycle, turning it to a real multimedia platform. Needs installation kit 2S000759.





MGX-21

MOTO GUZZI®



**CUPOLINO MAGGIORATO
FLYSCREEN XL**

.....
COD. 25000805

Il cupolino maggiorato permette di migliorare la protezione aerodinamica accentuando allo stesso tempo l'inconfondibile stile del batwing MGX-21.

The extended flyscreen improves comfort and wind protection, while emphasising the unique look of the MGX-21.



**SPECCHI IN ALLUMINIO NERI
BLACK MIRRORS**

.....
COD. 25000790

Realizzati in prezioso alluminio ricavato dal pieno, sono il completamento ideale all'estetica di MGX-21, 100% omologati e sicuri nella guida su strada.

These billet aluminium mirrors are homologated for road use and add the finishing touch to your MGX-21.



**LEVA FRENO NERA
BLACK BRAKE LEVER**

.....
COD. 25000791

Realizzata in prezioso alluminio ricavato dal pieno, rende unica e preziosa la zona dei comandi a manubrio di MGX-21, 100% omologata e sicura nella guida su strada, permette la regolazione su 4 posizioni.

Adjustable through four spans to achieve your ideal riding position, this bespoke billet aluminium brake lever is homologated for road use.



**LEVA FRIZIONE NERA
BLACK CLUTCH LEVER**

.....
COD. 25000792

Realizzata in prezioso alluminio ricavato dal pieno, rende unica e preziosa la zona dei comandi a manubrio di MGX-21, 100% omologata e sicura nella guida su strada, permette la regolazione su 4 posizioni.

Adjustable through four spans to achieve your ideal riding position, this bespoke billet aluminium clutch lever is homologated for road use.



**COPERCHI POMPE FRENO E FRIZIONE
BRAKE AND CLUTCH RESERVOIR
COVERS**

.....
COD. 2S000793

In alluminio ricavato dal pieno, con anodizzazione nera, donano un'immagine ancora più preziosa e tecnica alla zona dei comandi a manubrio. Si installano sopra i coperchi serbatoio di serie.

Made from black anodised billet aluminium, these reservoir covers fit over the existing caps and complement the genuine accessory brake and clutch levers.



**SUPPORTO GPS/SMARTPHONE
GPS/SMARTPHONE SUPPORT**

.....
COD. 2S000789

In alluminio anodizzato nero, questa staffa si integra perfettamente nella vista degli strumenti di MGX-21 e permette una facile installazione dell'involucro Smartphone o GPS.

This black anodised aluminium support integrates perfectly with the MGX-21 cockpit and is compatible with any smartphone or GPS holder.



**COPRI INIETTORI CARBONIO
CARBON INJECTOR COVERS**

.....
COD. 2S000360

I copri iniettori, in vera fibra di carbonio, permettono di elevare la cura del dettaglio su MGX-21 grazie a materiali nobili e rende il look della moto ancora più aggressivo.

Show the world your great attention to detail with these carbon fibre injector covers.



**FIANCHETTI SOTTOSELLA CARBONIO
CARBON FIBRE UNDERSEAT
SIDE PANELS**

.....
COD. 2S000696

I fianchetti sottosella, in vera fibra di carbonio, permettono di elevare la cura del dettaglio su MGX-21 grazie a materiali nobili e rende il look della moto ancora più aggressivo.

Add these high-quality, carbon fibre underseat panels to your MGX-21 for extra stand out.



**COPPIA FARETTI A LED
LED RIDING LIGHTS KIT**

.....
COD. 2S000741
COD. 2S000355 kit installazione / mounting kit

I faretti a LED dal basso consumo energetico, con il loro corpo in alluminio e le ridotte dimensioni si integrano perfettamente nella moto, e permettono una maggiore visibilità e sicurezza durante la guida nelle ore notturne. 100% omologati.

Give to your Moto Guzzi even more presence with these street-legal, aluminium-bodied, LED riding lights. The low energy consumption and the small body are highlighting the premium technology of this accessory.



**COVER SERBATOIO CARBONIO
CARBON FIBRE TANK TOP PANEL**

.....
COD. 2S000361

La cover serbatoio in vero carbonio rende l'immagine del ponte di comando di MGX-21 ancor più preziosa ed aggressiva.

The MGX-21 is the ultimate stealth bike, but carbon fibre accessories like this tank top cover take it to another level.



**PROTEZIONI LATERALI CILINDRI
CYLINDER HEAD CRASH PROTECTORS**

.....
COD. 2S000799

Le protezioni teste cilindro, in alluminio ricavato dal pieno con staffe in acciaio Inox, garantiscono protezione e solidità in caso di caduta. Allo stesso tempo aggiungono all'immagine della moto un tocco di sportività e consistenza.

Form and function, these stainless steel and billet aluminium head protectors give added protection in the event of a fall and perfectly highlight the mighty V-twin engine.



**PROTEZIONE CALORE CILINDRI
CYLINDER HEAD HEAT
DEFLECTORS**

.....
COD. 2S000800

Realizzati in acciaio INOX migliorano il comfort di guida proteggendo il pilota dal calore del motore. Il design ricco e curato di questo componente sottolinea l'immagine "dark" di MGX-21.

developped in a precious dark design, to deflect the heat and increase comfort, these black stainless steel shields are the most stylish way.



**COVER PEDANE PILOTA
RIDER FOOTPEG COVERS**

.....
COD. 2S000796

In alluminio ricavato dal pieno, anodizzate in colore nero, danno un ulteriore tocco di aggressività all'immagine, migliorando allo stesso la sensazione di controllo della moto.

Made from black anodised billet aluminium, these footpeg covers add extra attitude and style to your MGX-21.



**COVER PEDANE PASSEGGERO
PASSENGER FOOTPEG COVERS**

.....
COD. 2S000797

In alluminio ricavato dal pieno, anodizzate in colore nero, danno un ulteriore tocco di aggressività all'immagine, migliorando allo stesso la sensazione di controllo della moto.

Made from black anodised billet aluminium, these footpeg covers add extra attitude and style to your MGX-21.



**COVER PEDALINO FRENO POSTERIORE
BLACK ANODIZED ALUMINUM
BRAKE PEDAL**

.....
COD. 2S000803

Il pedalino freno posteriore, in alluminio ricavato dal pieno, anodizzato nero, si installa facilmente al posto del gommino, aumentando la sicurezza ed il feeling con la moto. Completamento ideale per lo stile "dark rider" di MGX-21.

The small things count the most and this black anodised billet aluminium brake pedal is the perfect complement for the MGX-21 Dark Rider style.



**COVER LEVA CAMBIO
GEAR SHIFT LEVER DECORATIVE TRIM**

.....
COD. 2S000804

La cover leva cambio, in alluminio ricavato dal pieno, anodizzata nera, si installa facilmente sulla leva flatboards e completa lo stile "dark rider" di MGX-21.

This black anodised billet aluminium cover complements the footboard gear lever and completes the Dark Rider style.



**FOOTBOARDS
RIDER FOOTBOARDS**

.....
COD. 2S000801

In alluminio, ricavato dal pieno, anodizzato nero, trasformano completamente l'immagine della moto e portano il livello di comfort e piacere di guida al massimo livello. Necessitano di apposito kit installazione e pedali 606467M.

In billet aluminium, black anodized, are able to completely transform the look of MGX-21 and bring the riding experience to a next level in comfort and pleasure. Need installation kit and levers 606467M.



**COVER LEVA FRENO POSTERIORE
REAR BRAKE LEVER TRIM**

.....
COD. 2S000802

La cover pedale freno, in alluminio ricavato dal pieno, anodizzata nera, si installa facilmente sulla leva flatboards e completa lo stile "dark rider" di MGX-21.

This black anodised billet aluminium cover complements the footboard rear brake lever and completes the Dark Rider style.



**ROSETTE FORCELLONE
SWINGARM WASHERS**

.....
COD. 2S000794

Rosette speciali realizzate in alluminio ricavate dal pieno ed anodizzate in nero per personalizzare lo stile della moto.

Special washers made of billet aluminium, black anodizes, to personalize the style of your motorbike.



**COVER SERBATOIO OLIO FRENO POST
REAR BRAKE RESERVOIR COVER**

.....
COD. 2S000795

Realizzato in alluminio ricavato dal pieno, con una finitura anodizzata nera, personalizza il look della moto. Ricopre completamente il corpo del serbatoio olio freno lasciando inalterate le funzionalità. È di facile installazione.

Made from billet aluminium, with a black anodised finish, it customizes the look of the vehicle. Covers completely the body of the brake oil tank, without altering the functions. Easy to mount.



**BENDE SCARICO
BLACK EXHAUST HEAT TAPE**

.....
COD. 605993M

In colore nero, rendono ancora più aggressiva la parte iniziale dello scarico MGX-21, sottolineando il carattere deciso e sportivo della moto.

These black exhaust heat tapes enhance the street look of your MGX-21.



**SCARICO OMOLOGATO SOUND
STREET LEGAL "SOUND" EXHAUST**

.....
COD. 2S000740

Gli scarichi "Sound" originali Moto Guzzi, grazie anche ad un fondello completamente rivisto anche dal punto di vista del design, garantiscono ad MGX-21 un "tono di voce" ancora più deciso ed originale. 100% omologati.

Let them know you're packing 1,400cc of Moto Guzzi V-twin soul with this street-legal "SOUND" exhaust system.



**BORSA SERBATOIO IN PELLE
LEATHER TANK BAG**

.....
COD. 2S000786

In pellame italiano di prima qualità, grazie alla buona capienza ed alle tasche di cui è dotata, migliora le esperienze di viaggio con MGX-21. Dispone di pratiche maniglie per il trasporto e di cover impermeabile. Necessita della cover serbatoio in pelle 2S000524 per il montaggio.

Large enough for the items you'll need close to hand, this stylish tank bag made from premium Italian leather, adds a touch of stylish practicality to your MGX-21. Needs the leather tank cover 2S000524 for mounting.



**BAULE IN PELLE PER MINI
PORTAPACCHI
SMALL LEATHER TOP BOX FOR
REAR RACK**

.....
COD. 2S000785

In pellame italiano di prima qualità, con un design che si integra perfettamente con la moto e rifinito con fibbie in alluminio e logo Moto Guzzi in rilievo, migliora l'esperienza di viaggio con MGX-21. Si installa facilmente e dispone di cover impermeabile.

Enhance your MGX-21 luggage capacity with this bespoke top box. Made from premium Italian leather, this easy to install top box features an embossed Moto Guzzi logo, aluminium buckles and a removable rain cover.





**COVER SELLINO PASSEGGERO
IN CARBONIO
SOLO SEAT CARBON COVER**

.....
COD. 2S000699

Creata appositamente per i "viaggiatori solitari" la cover sella passeggero in vero carbonio rende l'immagine della coda di MGX-21 ancor più snella ed aggressiva. Si installa facilmente al posto della sella passeggero.

For the times when you would rather ride alone, this carbon fibre seat cowl mirrors the aggressive lines of MGX-21 and is easily fitted.



**PORTAPACCHI IN CARBONIO
SMALL CARBON FIBRE REAR RACK**

.....
COD. 2S000775

Il portapacchi posteriore, in vero carbonio come altre componenti, si integra perfettamente nella linea filante ed aggressiva della moto. Si installa facilmente al posto della sella passeggero, senza penalizzare la linea e permettendo di aumentare notevolmente la capacità di carico o di montare l'apposito bauletto in pelle.

Specifically designed to perfectly match the unique shape of your MGX-21, this carbon fibre rack replaces the passenger seat to give increased luggage capacity, or as a mount for the accessory leather top box.



**TELO COPRI VEICOLO DA INTERNO
INDOOR BIKE COVER**

.....
COD. 606454M

Realizzato in tessuto elastico speciale, che si adatta perfettamente alle forme di MGX-21 ed ai suoi accessori. Ideale per proteggere la vostra preziosa motocicletta durante le soste in garage. Grafica dedicata MGX-21.

A bike as special as the MGX-21 shouldn't be left exposed. This shape-forming cover perfectly hugs your Moto Guzzi, with or without accessories, to protect it when garage parked.



**SELLA PILOTA COMFORT
MEMORY FOAM RIDER SADDLE**

.....
COD. 2S000787

La sella comfort per MGX-21 riprende le forme di quella originale ma è dotata di un'imbottitura che permette minori vibrazioni e lunghe percorrenze alla guida in pieno comfort. Il rivestimento in materiale speciale e l'apposita etichettatura garantiscono comunque un effetto estetico superiore.

Mirroring the shape of the standard seat, but made from memory foam upholstered with "Easy Touch" material, this comfort saddle not only looks great, but also lets you enjoy your MGX-21 on even longer journeys.



**SELLA PASSEGGERO COMFORT
MEMORY FOAM PASSENGER
SADDLE**

.....
COD. 2S000788

La sella comfort per MGX-21 riprende le forme di quella originale ma è dotata di un'imbottitura che permette lunghe percorrenze alla guida in pieno comfort. Il rivestimento in materiale Easy Touch e l'apposita etichettatura garantiscono comunque un effetto estetico superiore.

With same features and benefit of rider accessory saddle, this memory foam passenger seat lets your passenger enjoy those longer journeys as well.



AUDACE

CARBON



MOTO GUZZI®



**CORNICE FARO NERA
BLACK HEADLAMP FRAME**

.....
COD. 2S000946

Lo spirito Dark della tua Audace raggiunge l'apice con questo semplice dettaglio estetico che rende il frontale della tua moto ancora più forte e deciso.

The Dark Soul of Audace reach the top with this aesthetic detail that complete the strong and determined style of the front of Your motorcycle.



**COPPIA FARETTI A LED
LED RIDING LIGHTS KIT**

.....
COD. 2S000741
COD. 2S000355 kit installazione / mounting kit

I faretto a LED dal basso consumo energetico, con il loro corpo in alluminio e le ridotte dimensioni si integrano perfettamente nella moto, e permettono una maggiore visibilità e sicurezza durante la guida nelle ore notturne. 100% omologati.

Give to your Moto Guzzi even more presence with these street-legal, aluminium-bodied, LED riding lights. The low energy consumption and the small body are highlighting the premium technology of this accessory.



**SPECCHI "DARK"
GAMBO ESTERNO
EXTERNAL STEM MIRRORS
"DARK"**

.....
COD. 2S000330

Realizzati in alluminio ricavato dal pieno, anodizzati neri, con il loro design semplice ma di tendenza contribuiscono a donare eleganza alla moto. Si applicano al posto dei terminali manubrio.

Made of billet aluminium, black anodized, contribute with their clean but trendy design they add elegance to motorcycle look. Have to be mounted in replacement of handlebar ends.



**SPECCHI "DARK" GAMBO CORTO
SHORT STEM MIRRORS "DARK"**

.....
COD. 2S000331

Realizzati in alluminio ricavato dal pieno, anodizzati neri, con il loro design semplice ma di tendenza contribuiscono a donare eleganza alla moto. La coppa specchio con gambo ribassato racchiude il massimo della tecnologia realizzativa che si esprime in alcune lavorazioni speciali realizzate sui tre assi. Sono omologati per tutti i paesi.

Made of billet aluminium, black anodized, contribute with their clean but trendy design they add elegance to motorcycle look. Have to be mounted in replacement of handlebar ends. The mirror cover, with his lowered stem, express the maximum of technology capability with some exclusive works performed on tree axes. They are approved for all countries.





**ROSETTE FORCELLONE NERE
BLACK SWINGARM WASHERS**

.....
COD. 2S000794

Rosette speciali realizzate in alluminio ricavate dal pieno ed anodizzate in nero per personalizzare lo stile della moto.

Special washers made of billet aluminium, black anodizes, to personalize the style of your motorbike.



**TERMINALI MANOPOLE
"ROUND" NERI
HANDLEBAR ENDPIPES
"ROUND" BLACK**

.....
COD. 2S000336

I terminali manopole "Round", realizzati in alluminio ricavato dal pieno anodizzati neri, si accoppiano alle manopole "Dark", realizzando un perfetto completamento stilistico ed estetico.

The "Round" handlebar ends, made in black anodized billet aluminium, match the "dark" handlebar grips, achieving a perfect stylistic and aesthetic finishing.



**LEVA FRENO ANTERIORE
"DARK" NERA
FRONT BRAKE LEVER "DARK" BLACK**

.....
COD. 606440M

Realizzata in alluminio ricavata dal pieno, anodizzata nera, grazie alla sua consistenza ed alle sue regolazioni eleva il comfort di guida impreziosendo il look della moto.

Made in billet aluminium, black anodized, due to consistency and adjustability, elevate the driving comfort giving a stylish look to the motorcycle.



**COPERCHIO POMPA FRENO
E FRIZIONE NERE
BLACK BRAKE AND CLUTCH
RESERVOIR COVER**

.....
COD. 606444M

Speciali coperchi delle pompe freno e frizione realizzati in alluminio ricavati dal pieno anodizzati neri.

Special covers of the brake pumps and clutch made from black anodized billet aluminium.



**TERMINALI MANOPOLE
"CORSA" NERI
GRIPS ENDPIPES "CORSA" BLACK**

.....
COD. 2S000338

I terminali manopole "Corsa", realizzati in alluminio ricavato dal pieno anodizzati neri, si accoppiano alle manopole "Dark", realizzando un perfetto completamento stilistico ed estetico.

The "Corsa" handlebar ends, made in black anodized billet aluminium, match the "dark" handlebar grips, achieving a perfect stylistic and aesthetic finishing.



**LEVA FRIZIONE "DARK" NERA
CLUTCH LEVER "DARK" BLACK**

.....
COD. 606441M

Realizzata in alluminio ricavata dal pieno, anodizzata nera, grazie alla sua consistenza ed alle sue regolazioni eleva il comfort di guida impreziosendo il look della moto.

Made from billet aluminium, black anodized, due to its consistency and adjustments, it elevates the driving comfort giving a stylish look to the motorcycle.



**COVER TAPPI FORCELLA NERI
BLACK FORK TOP CAPS COVER**

.....
COD. 2S000400

Realizzati in alluminio ricavato dal pieno anodizzati neri, facilmente installabili, sono stabilmente fissati alle viti che chiudono gli steli forcella mediante un piccolo grano in acciaio.

Made in black anodized billet aluminium, these covers are easy to be mounted and strongly fixed to the fork top stems thanks to a small steel peg.



**COVER CLACSON
IN ALLUMINIO NERI
BLACK ALUMINIUM HORNS COVERS**

.....
COD. 2S000462

Cover in alluminio ricavato dal pieno anodizzate nere, si applicano ai clacson per dare un look sportivo alla moto.

Cover made from billet aluminium black anodized, applied on the horns they give a sportive look to the motorcycle.



**PARAMOTORE IN TUBO NERO
BLACK ENGINE GUARD**

.....
COD. 25000366

Disegnato dal Centro Stile Moto Guzzi e realizzato in tubo da 1 1/4" con pareti di grosso spessore, offre una protezione specifica al motore ed alle gambe del pilota. Il suo disegno segue con armonia le linee del veicolo, unendo stile alla funzionalità.

Designed by the Moto Guzzi Style Dept. it offers a protection for the engine or for the rider's legs. The specific soft curve shape adds style to functionality.



**PROTEZIONE CALORE CILINDRI
CYLINDER HEAD HEAT
DEFLECTORS**

.....
COD. 25000800

Realizzati in acciaio INOX migliorano il comfort di guida proteggendo il pilota dal calore del motore. Il design ricco e curato di questo componente sottolinea l'immagine "dark" del veicolo.

developped in a precious dark design, to deflect the heat and increase comfort, these black stainless steel shields are the most stylish way.



**SELLA COMFORT GEL
COMFORT GEL SADDLE**

.....
COD. 25000602

Questa sella presenta un inserto in gel nella zona della seduta che garantisce maggiore comodità ed una riduzione delle vibrazioni. La copertura presenta la punzonatura del logo "COMFORT Gel".

This saddle has a gel inserted on the seating area that ensures higher comfort and reduction in vibration. The "COMFORT Gel" logo is punched on the cover.



**COVER SERBATOIO IN CARBONIO
CARBON FIBRE TANK TOP PANEL**

.....
COD. 25000361

La cover serbatoio in vero carbonio rende l'immagine del ponte di comando di Audace ancor più preziosa ed aggressiva.

Audace is the ultimate muscle bike, but carbon fibre accessories like this tank top cover take it to another level.



**COPRI INIETTORI CARBONIO
CARBON INJECTOR COVERS**

.....
COD. 25000360

I copri iniettori, in vera fibra di carbonio, permettono di elevare il look muscoloso di Audace grazie a materiali forti e rende il look della moto ancora più aggressivo.

Show the world your great attention to detail with these carbon fibre injector covers.



**PROTEZIONI LATERALI CILINDRI NERE
BLACK CYLINDER HEAD CRASH
PROTECTORS**

.....
COD. 25000799

Le protezioni teste cilindro, in alluminio ricavato dal pieno con staffe in acciaio Inox, garantiscono protezione e solidità in caso di caduta. Allo stesso tempo aggiungono all'immagine della moto un tocco di sportività e consistenza.

Form and function, these stainless steel and billet aluminium head protectors give added protection in the event of a fall and perfectly highlight the mighty V-twin engine.





COVER TESTE CON LAVORAZIONE GRIGIO
CYLINDERS COVERS - GREY

.....
 COD. 2S000364

Eleganti cover teste cilindro verniciate, con speciali lavorazioni eseguite in fresatura, rappresentano uno speciale elemento di personalizzazione del veicolo.

Elegant painted cylinder heads covers, with special processes performed in milling, they represent a special element of customization to the vehicle.



SET BUSSOLE TESTATA IN ALLUMINIO
ALUMINIUM HEAD BUSHINGS SET

.....
 COD. 2S000348

Set di quattro distanziali estetici in alluminio ricavato dal pieno, da montare in sostituzione delle viti che fissano le cover delle teste cilindro. Le viti a corredo sono in acciaio inox lucidato.

Set of four aesthetic spacers made from billet aluminium, to be mounted in place of the screws that hold the cover of the cylinder head. The screws supplied with the vehicle are made of polished stainless steel.



COVER FORI BASAMENTO MOTORE - NERO
CRANKCASE ENGINE HOLES COVER - BLACK

.....
 COD. 2S000399

Realizzati in alluminio tagliato al laser e anodizzati neri, consentono di coprire i fori di lavorazione di basamento del motore. La scritta "1400" realizzata al laser, esplica la cilindrata del veicolo.

Made of polished laser-cut and black anodized aluminium, they cover the machining holes of the engine crankcase. The laser-engraved "1400" text denotes the cylinder capacity of the vehicle.



COVER SERBATOIO OLIO FRENO POSTERIORE
REAR BRAKE RESERVOIR COVER

.....
 COD. B064288

Realizzato in alluminio ricavato dal pieno, con una finitura lucida, personalizza il look del veicolo. Ricopre completamente il corpo del serbatoio olio freno lasciando inalterate le funzionalità. È di facile installazione.

Made in billet aluminium, with polished finishing, it customise the look of the vehicle. It wrap completely the brake oil tank without compromise the function. Easy to mount.



**COVER LEVA CAMBIO
GEAR SHIFT LEVER DECORATIVE TRIM**

.....
COD. 2S000804

La cover leva cambio, in alluminio ricavato dal pieno, anodizzata nera, si installa facilmente sulla leva flatboards e completa lo stile "dark rider" del veicolo.

This black anodised billet aluminium cover complements the footboard gear lever and completes the Dark Rider style.



**PEDANE PILOTA IN ALLUMINIO
ALUMINIUM RIDER FOOTREST**

.....
COD. 2S000346 ALLUMINIO/ALUMINIUM
COD. 2S000796 NERO/BLACK

Pregevoli cover in alluminio ricavate dal pieno, si montano in sostituzione della gomma montata di serie. Le fresature realizzano un disegno specifico e garantiscono il massimo grip in ogni condizione di guida.

Fine covers from billet aluminium, they are mounted in replacement of the standard rubbers. The milling draws a specific design to guarantee the maximum grip in all driving conditions.



**COVER LEVA FRENO POSTERIORE
REAR BRAKE LEVER TRIM**

.....
COD. 2S000802

La cover pedale freno, in alluminio ricavato dal pieno, anodizzata nera, si installa facilmente sulla leva flatboards e completa lo stile "dark rider" del veicolo.

This black anodised billet aluminium cover complements the footboard rear brake lever and completes the Dark Rider style.



**COVER PEDALINO FRENO POSTERIORE
BLACK ANODIZED ALUMINIUM
BRAKE PEDAL**

.....
COD. 2S000803

Il pedalino freno posteriore, in alluminio ricavato dal pieno, anodizzato nero, si installa facilmente al posto del gommino, aumentando la sicurezza ed il feeling con la moto. Completamento ideale per lo stile "dark rider" del veicolo.

The small things count the most and this black anodised billet aluminium brake pedal is the perfect complement for the Dark Rider style.



**PEDANE PASSEGGERO IN ALLUMINIO
ALUMINIUM PASSENGER FOOTREST**

.....
COD. 2S000797 NERO/BLACK
COD. 2S000347 ALLUMINIO/ALUMINIUM

Pregevoli cover in alluminio ricavate dal pieno, si montano in sostituzione della gomma montata di serie. Le fresature realizzano un disegno specifico e garantiscono il massimo grip in ogni condizione di guida.

Fine covers from billet aluminium, they are mounted in replacement of the standard rubbers. The milling draws a specific design to guarantee the maximum grip in all driving conditions.



**FOOTBOARDS
RIDER FOOTBOARDS**

.....
COD. 2S000801

In alluminio, ricavato dal pieno, anodizzato nero, trasformano completamente l'immagine della moto e portano il livello di comfort e piacere di guida al massimo livello. Necessitano di apposito kit installazione e pedali 606467M.

In billet aluminium, black anodized, are able to completely transform the look of MGX-21 and bring the riding experience to a next level in comfort and pleasure. Need installation kit and levers 606467M



**BORSE LATERALI CANVAS
CANVAS SIDE BAGS**

.....
COD. 2S000907

In pregiato tessuto e rifiniture in pelle, queste borse morbide si applicano facilmente e velocemente agli appositi supporti grazie agli attacchi Fast Click. Necessitano del kit montaggio 2S000568.

In precious fabric and leather finishing, these bags can be easily and quickly applied on the vehicle thanks to Fast Click release system. Needs mounting support 2S000568.



**BORSE LATERALI IN PELLE
PREMIUM LEATHER SIDE BAGS**

.....
COD. 2S000522
COD. 2S000568 kit installazione/installation kit

Pelle di prima scelta, cura dei dettagli ed una finitura che rispecchia la concia artigianale delle pelletterie italiane. Sono dotate di uno sgancio rapido e di sistema di sicurezza antifurto che ne permettono un comodo utilizzo, dal quotidiano al viaggio. Necessitano degli appositi supporti 2S000568.

These quick release side bags are made of made of premium Italian leather, are equipped with a quick release and safe locking system, useful on everything from daily trips to long trips. Comes with carrying strap. Installation requires mounting support 2S000568.



GUZZI MULTIMEDIA PLATFORM

.....
COD. 606522M

GMP è il nuovo dispositivo che consente di collegare il proprio Smartphone alla moto, trasformandola in una vera e propria piattaforma multimediale.

GMP is the new device that allows you to connect your smartphone to the motorcycle, turning it to a real multimedia platform.



KIT SUPPORTO USB USB SOCKET KIT

.....
COD. 25000315

Presse USB fornita di supporto dedicato per installazione nel sottosella, per la ricarica dei supporti elettronici, non consente il dialogo con gli apparati elettronici del mezzo.

USB socket with bracket for installation under the saddle, to recharge the electronic media, does not allow dialogue with the electronic devices of the vehicle.



ALLARME ELETTRONICO ELECTRONIC ALARM

.....
COD. 2D000027

Sistema di allarme compatto radiocomandato e autoalimentato di ultima generazione. Tra le sue specifiche offre: blocco motore, sensore di spostamento integrato, elevato livello di protezione.

State of the art self-powered remote control compact alarm system. Its specifications include: engine block, built in motion sensor, high protection degree.



TELO COPRIMOTO AUDACE EAGLE "EAGLE" AUDACE BIKE COVER

.....
COD. 606166M

Telo su misura da interno per la protezione dalla polvere da utilizzare durante le soste in garage della moto.

È realizzato in un tessuto elasticizzato con grafica speciale.
Tailor-made motorcycle cover for inside to protect against dust, intended for use during long periods of storing the bike in a garage. It is made of stretch fabric with special graphics.



ELDORADO





**PARABREZZA MEDIO
SUPPORTI RIBASSATI
MEDIUM WINDSHIELD
LOWER BRACKETS**

.....
COD. 2S000544

Parabrezza di misura media con la lastra in Lexan antiurto e antigraffio. Omologato secondo le normative DOT. Si monta facilmente grazie ai supporti ribassati da acquistare separatamente. H44 x L52 cm.

Medium sized windshield with shockproof and scratch resistant Lexan sheet. Approved according to the DOT standards. It is easy to mount due to its lowered brackets, to be purchased separately. H44xL52 cm.



**PARABREZZA SPORT
SUPPORTI RIBASSATI
SPORT WINDSHIELD
LOWER BRACKETS**

.....
COD. 2S000548

Parabrezza di misura particolarmente ridotta, con la lastra in Lexan antiurto e antigraffio, che mantiene inalterate le caratteristiche di trasparenza e lucentezza. Omologato secondo le normative DOT. Si monta facilmente grazie ai supporti ribassati da acquistare separatamente. H34 x L41 cm.

Specially reduced windshield with shockproof and scratch resistant Lexan sheet, maintaining the transparency and gloss characteristics unaltered over time. Approved according to the DOT standards. It is easy to mount due to its lowered brackets, to be purchased separately. H34 x L41 cm.



**SUPPORTI PARABREZZA
RIBASSATI
WINDSHIELD LOWER BRACKETS**

.....
COD. 2S000542

Robusto kit di fissaggio, a misura ridotta, dotato di supporti specifici per il montaggio del parabrezza. Necessita delle minuterie 606255M.

Small sized solid fastening kit, equipped with specific brackets for mounting the windshield. Requires 606255M small metallic parts.



**PARABREZZA MEDIO
SUPPORTI STANDARD
MEDIUM WINDSCREEN
STANDARD BRACKETS**

.....
COD. 2S000546

Parabrezza di misura media con la lastra in Lexan antiurto e antigraffio, che mantiene nel tempo inalterate le caratteristiche di trasparenza e lucentezza. Omologato secondo le normative DOT. Si monta facilmente grazie ai supporti Standard da acquistare separatamente. H44 X L52 cm.

Medium sized windshield with shockproof and scratch resistant Lexan sheet, maintaining the transparency and gloss characteristics unaltered over time. Approved according to the DOT standards. Can be easily mounted due to the standard brackets, to be purchased separately. H44 X L52 cm.



**PARABREZZA-SUPPORTI STANDARD
WINDSHIELD-STANDARD BRACKETS**

.....
COD. 605854M

Parabrezza con la lastra in Lexan antiurto e antigraffio, un materiale pregiatissimo che assicura la massima durata nel tempo mantenendo inalterate le sue caratteristiche di trasparenza e lucentezza. Il Lexan è omologato secondo le ferree normative DOT americane. H57 x L58 cm.

Windshield made in shockproof and scratch resistant Lexan sheet, a precious material that ensures maximum durability, maintaining its transparency and gloss characteristics unaltered over time. Lexan is approved according to the strict American DOT regulations. H57 x L58 cm.



**DEFLETTORI ARIA PARABREZZA
WINDSHIELD AIR FLAPS**

.....
COD. B064235

Appendici da applicare nella zona sottostante al parabrezza per aumentare la protezione ed il comfort di guida offerti al pilota.

Spoilers to be applied under the windshield to increase rider's protection and driving comfort.



**LUCI SUPPLEMENTARI
FOG LIGHTS**

.....
COD. B064251

I fari supplementari offrono una migliore visibilità durante la guida notturna e si integrano perfettamente con il look del veicolo grazie alle finiture cromate. I due fari vengono installati sotto gli indicatori di direzione tramite staffe appositamente studiate per non compromettere la guidabilità del mezzo.

The additional headlamps offer better visibility during night driving, completing perfectly the look of the vehicle thanks to their chromed finishing. The two headlamps are mounted under the turn indicators with clamps specifically designed to avoid compromising the driving of the vehicle.



**COPPIA FARETTI A LED
LED RIDING LIGHTS KIT**

.....
COD. 2S000741
COD. 2S000355 kit installazione / mounting kit

I faretti a LED dal basso consumo energetico, con il loro corpo in alluminio e le ridotte dimensioni si integrano perfettamente nella moto, e permettono una maggiore visibilità e sicurezza durante la guida nelle ore notturne. 100% omologati.

Give to your Moto Guzzi even more presence with these street-legal, aluminium-bodied, LED riding lights. The low energy consumption and the small body are highlighting the premium technology of this accessory.



**PARABREZZA GRANDE
SUPPORTI STANDARD
WIDE WINDSCREEN
STANDARD BRACKETS**

.....
COD. 2S000547

Parabrezza di misura grande con la lastra in Lexan antiurto e antigraffio, che mantiene nel tempo inalterate le caratteristiche di trasparenza e lucentezza. Omologato secondo le normative DOT. Si monta facilmente grazie ai supporti standard da acquistare separatamente. H70 x L59 cm.

Large sized windshield made in shockproof and scratch resistant Lexan sheet, maintaining the transparency and gloss characteristics unaltered over time. Approved according to the DOT standards. Can be easily mounted due to the standard brackets, to be purchased separately. H70 x L59 cm.



**SUPPORTI PARABREZZA
WINDSCREEN BRACKETS**

.....
COD. 605853M

Robusto kit di fissaggio, a misura standard, dotato di supporti specifici per il montaggio del parabrezza. Necessita delle minuterie 606255M.

Standard size solid fastening kit, equipped with specific brackets for windshield mounting. Requires 606255M small metallic parts.



**COVER CLACSON IN ALLUMINIO
ALUMINIUM HORNS COVER**

.....
COD. 2S000466 - MY16

Cover in alluminio ricavato dal pieno, si applica ai clacson per dare un look sportivo alla moto.

The billet aluminium cover is applied to the horns giving the motorcycle a sportive look.



**CORNICE RADIATORE OLIO
OIL RADIATOR FRAME SET**

.....
COD. 2S000349 - MY16

Realizzato in alluminio lucidato tagliato al laser, completo di rete protettiva, si applica al radiatore conferendo un look classico e raffinato.

Made in polished laser-cut aluminium, completed with protective grid, it is applied to the radiator giving a classic and stylish look.



**SPECCHI "JOURNEY" IN ALLUMINIO
ALUMINIUM MIRRORS KIT "JOURNEY"**

.....
COD. 2S000333

Realizzati in alluminio ricavato dal pieno con il loro design semplice ma di tendenza contribuiscono a donare eleganza alla moto. La coppa specchio racchiude il massimo della tecnologia realizzativa che si esprime in alcune lavorazioni speciali realizzate sui tre assi. Sono omologati per tutti i Paesi.

Made from billet aluminium they contribute with their simple, but trendy design to add elegance to the motorcycle. The mirror cover contains the maximum state of the technology expressed in some special works performed on the three axes. They are approved for all countries.



**MANUBRIO TOURING CROMATO NERO
BLACK CHROMED HANDLEBAR TOURING**

.....
COD. B064246 - MY16

Per una personalizzazione esclusiva della propria moto, sviluppato dai collaudatori Moto Guzzi, il manubrio cromato nero consente di mantenere la posizione di guida ottimale per il controllo della moto. Da oliare periodicamente per proteggere e mantenere lucida la cromatura.

For an exclusive customization of your motorcycle, developed by the Moto Guzzi testers, the black chrome handlebar keeps the optimum driving position for the control of the motorcycle. To be oiled regularly to protect and maintain the gloss of the chromium coating.



**MANOPOLE "JOURNEY" IN ALLUMINIO
ALUMINIUM HANDGRIP KIT "JOURNEY"**

.....
COD. 2S000335 - MY16 (no ride by wire)

Realizzate in alluminio ricavate dal pieno, impreziosiscono il manubrio della moto donandole un look personalizzato ed elegante, sono predisposte per il montaggio dei terminali "Round".

Made from billet aluminium, they embellish the handlebar of the motorcycle, giving a personal and elegant look. Compatible with "round" ends.



**SUPPORTO GPS
GPS BRACKET**

.....
COD. B064243

Supporto realizzato in acciaio inox lucido con predisposizione per il montaggio del navigatore satellitare.

Bracket made of glossy stainless steel with arrangement for mounting the satellite navigator.



**MANOPOLE RISCALDATE
HEATED HANDGRIPS**

.....
COD. B064270 - MY16 (no ride by wire)

Per chi ama viaggiare a lungo in tutte le stagioni, facilmente installabili grazie alla predisposizione presente su tutte le California. Contribuiscono al comfort di guida, evitando che le mani possano indolenzirsi a causa del freddo.

For those who love travelling in all seasons, easily mountable due to the arrangement on all California. They contribute to the driving comfort, preventing hand stiffening because of the cold.



**TERMINALI MANOPOLE "ROUND"
ALUMINIUM GRIPS ENDPIPES "ROUND"**

.....
COD. 2S000337

I terminali manopole "Round", realizzati in alluminio ricavato dal pieno, si accoppiano alle manopole "Journey", realizzando un perfetto completamento stilistico ed estetico.

The "Round" handlebar ends, made from billet aluminium, match the "Journey" handlebars, achieving a perfect stylistic and aesthetic finishing.





**TERMINALI MANOPOLE "CORSA"
IN ALLUMINIO
ALUMINIUM GRIPS ENDPIPES
"CORSA"**

.....
COD. 2S000339

I terminali manopole "Corsa", realizzati in alluminio ricavato dal pieno, si accoppiano alle manopole "Journey", realizzando un perfetto completamento stilistico ed estetico.

The "Corsa" handlebar ends, made from billet aluminium, match the journey grips, achieving a perfect stylistic and aesthetic finishing.



**TERMINALI MANOPOLE "CLASSIC"
GRIPS ENDPIPES "CLASSIC"**

.....
COD. 2S000341

I terminali manopole "Classic", realizzati in alluminio ricavato dal pieno, si accoppiano alle manopole standard, realizzando un perfetto completamento stilistico ed estetico.

The "Classic" handlebar ends, made from billet aluminium, match the standard grips, achieving a perfect stylistic and aesthetic finishing.



**LEVA FRENO ANTERIORE
"JOURNEY" IN ALLUMINIO
ALUMINIUM FRONT BRAKE
LEVER "JOURNEY"**

.....
COD. 606439M

Realizzata in alluminio ricavata dal pieno, grazie alla sua consistenza ed alle sue regolazioni eleva il comfort di guida impreziosendo il look della moto.

Made from billet aluminium, due to its consistency and adjustments, it increases the driving comfort embellishing the look of the motorcycle.



**COVER TAPPI FORCELLA
IN ALLUMINIO
ALUMINIUM FORK TOP CAPS COVER**

.....
COD. 2S000402

Realizzati in alluminio ricavato dal pieno, facilmente installabili, sono stabilmente fissati alle viti che chiudono gli steli forcella mediante un piccolo grano in acciaio.

Made of billet aluminium, easy to mount, they are solidly fastened to the screws that fix the fork stems with a small steel peg.



**COPERCHIO POMPA
FRENO E FRIZIONE
BRAKE AND CLUTCH
RESERVOIR COVER**

.....
COD. B064259

Speciali coperchi delle pompe freno e frizione realizzati in alluminio ricavati dal pieno con finitura antigraffio lucida.

Special covers for brake and clutch pumps made from billet aluminium with glossy scratch resistant finishing.



**LEVA FRIZIONE "JOURNEY"
IN ALLUMINIO
ALUMINIUM CLUTCH
LEVER "JOURNEY"**

.....
COD. 606438M

Realizzata in alluminio ricavata dal pieno, grazie alla sua consistenza ed alle sue regolazioni eleva il comfort di guida impreziosendo il look della moto.

Made from billet aluminium, due to its consistency and adjustments, it increases the driving comfort embellishing the look of the motorcycle.



**COPRI STELI FORCELLA
FORK SLEEVE COVERS**

.....
COD. B064252

I copri steli forcella con finitura cromata si abbinano agli altri elementi in alluminio, già presenti sul veicolo, per esaltare le zone laterali.

The fork sleeve covers with chrome finishing match the other aluminium elements, already mounted on the vehicle, to enhance the side areas.



**CRESTA PARAFANGO ANTERIORE
FRONT FENDER PEAK**

.....
COD. 2S000353

Realizzata in acciaio inox, tagliata ed incisa a laser, lucidata a mano, il suo montaggio sul parafrangente è garantito dalle speciali colonnine in acciaio inox. Completa il look classico della moto.

Made of stainless steel, laser-cut and engraved, manually polished, its mounting on the mudguard is guaranteed by two special stainless steel columns. Finishes the classical look of the motorcycle.

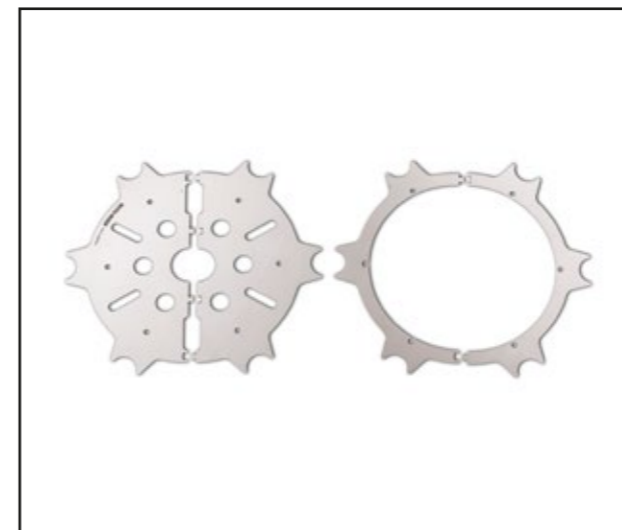

**COVER DISCHI FRENO ANTERIORE
FRONT BRAKE COVER**

.....
COD. 2S000467

Realizzati in acciaio inox tagliati a laser e lucidati a specchio, grazie alla loro lavorazione particolarmente precisa sono facilmente installabili sui dischi della ruota anteriore con bussole di fissaggio realizzate in alluminio ricavate dal pieno. Donano al veicolo un look cruiser.

Made in laser-cut and high-gloss polished stainless steel, thanks to their particular accurate machining, they can be easily mounted on the front wheel discs with fastening bushings made from billet aluminium. They provide the vehicle with a cruiser look.



**GUANCIALI SERBATOIO CROMATI
CHROMED TANK COVERS**

.....
COD. B064244

Le cover laterali del serbatoio cromate personalizzano lo stile della moto rendendola una vera «fuoriserie».

The side tank covers, made of steel with chromed finish, customize the style of the motorcycle, making it a "custom-built" vehicle.



**COVER TESTE CON LAVORAZIONE
GRIGIO
CYLINDERS COVERS - GREY**

.....
COD. 2S000364

Eleganti cover teste cilindro verniciate, con speciali lavorazioni eseguite in fresatura, rappresentano uno speciale elemento di personalizzazione del veicolo.

Elegant painted cylinder heads covers, with special processes performed in milling, they represent a special element of customization to the vehicle.



**COVER TESTE CON LAVORAZIONE
ROSSO
CYLINDERS COVERS - RED**

.....
COD. 2S000600

Eleganti cover teste cilindro verniciate, con speciali lavorazioni eseguite in fresatura, rappresentano uno speciale elemento di personalizzazione del veicolo.

Elegant painted cylinder heads covers, with special processes performed in milling, they represent a special element of customization to the vehicle.



**SET BUSSOLE TESTATA IN ALLUMINIO
ALUMINIUM HEAD BUSHINGS SET**

.....
COD. 2S000348

Set di quattro distanziali in alluminio ricavato dal pieno, da montare in sostituzione delle viti che fissano le cover delle teste cilindro. Le viti a corredo sono in acciaio inox lucidato.

Set of four aesthetic spacers made from billet aluminium, to be mounted in place of the screws supplied with the kit that hold the cover of the cylinder head. The screws supplied with the vehicle are made of polished stainless steel.



**PROTEZIONE TESTE
CYLINDER COVERS PROTECTION**

.....
COD. B064247

Speciali protezioni laterali cilindri realizzate in alluminio ricavato dal pieno finite con la lucidatura a specchio. Si integrano perfettamente con lo stile ed il design della moto. Complete di supporti in acciaio inox lucidati a specchio.

Special cylinder side shields made from billet aluminium, finished with high-gloss polishing. They perfectly match with style and design of the motorcycle. Provided with high-gloss polished stainless steel brackets.



**LEVA FRENO POSTERIORE
"JOURNEY" IN ALLUMINIO
ALUMINIUM REAR BRAKE LEVER
"JOURNEY"**

.....
COD. 2S000350

Cover realizzata in alluminio ricavata dal pieno, unitamente alla cover del pedalino del freno impreziosisce il comando freno posteriore.

Cover made of billet aluminium, together with the brake pedal cover embellishes the rear brake control.



**PEDALINO FRENO POSTERIORE
"JOURNEY" IN ALLUMINIO
ALUMINIUM FOOTSWITCH
BRAKE "JOURNEY"**

.....
COD. 2S000351

Cover per pedalino realizzata in alluminio ricavato dal pieno, con lavorazione per garantire il massimo grip. Unitamente alla cover leva freno posteriore impreziosisce notevolmente il look del comando freno posteriore.

Pedal cover made of billet aluminium, developed to guarantee the maximum grip. Together with the rear brake lever cover, embellishes significantly the look of the rear brake control.



**PARACALORE CILINDRI
THERMAL PROTECTION SET**

.....
COD. 2S000032

Ogni paracalore è realizzato in acciaio inox lucidato a specchio, con inserti in abs che migliorano il design ed attenuano il contatto delle ginocchia con il motore. Proteggono dal calore generato dal cilindro, per una guida più sicura e confortevole.

Each heat shield is made from high-gloss polished stainless steel, with abs inserts improving design and reducing the contact of the knees with the engine. They protect from the heat generated by the cylinder, for a more secure and comfortable driving.



**PARAURTI MOTORE ANTERIORE
ENGINE FRONT BUMPER**

.....
COD. B063588

Disegnato in tubo cromato dal Centro Stile Moto Guzzi, segue le linee della moto. Offre una protezione specifica al motore ed alle gambe del pilota.

Designed by the Moto Guzzi Style Centre, this bumper in chromed tube follows the lines of the motorcycle. It offers specific protection to the engine and driver's legs.



**LEVA CAMBIO "JOURNEY"
IN ALLUMINIO
ALUMINIUM GEAR LEVER
"JOURNEY"**

.....
COD. 2S000352

Cover realizzata in alluminio ricavata dal pieno, impreziosisce il comando cambio.

The cover made of billet aluminium embellishes the gear shift lever.



**COVER SERBATOIO OLIO FRENO
POSTERIORE
REAR BRAKE RESERVOIR COVER**

.....
COD. B064288

Realizzato in alluminio ricavato dal pieno, con una finitura lucida, personalizza il look del veicolo. Ricopre completamente il corpo del serbatoio olio freno lasciando inalterate le funzionalità. È di facile installazione.

Made from billet aluminium, with a polished finish, it customizes the look of the vehicle. Covers completely the body of the brake oil tank, without altering the functions. Easy to mount.



**COVER FORI BASAMENTO MOTORE
CRANKCASE ENGINE HOLES COVER**

.....
COD. 2S000403

Realizzati in alluminio tagliato al laser lucidati, consentono di coprire i fori di lavorazione di basamento del motore. La scritta "1400" realizzata al laser indica chiaramente la cilindrata del motore, evidenziando l'importanza del veicolo.

Made of polished laser-cut aluminium, they cover the machining holes on the engine crankcase. The laser made "1400" mark, gives a clear message regarding the size of the engine, underlining the exclusivity of the vehicle.



**ROSETTE FORCELLONE
SWINGARM WASHERS**

.....
COD. B064272

Rosette speciali realizzate in alluminio ricavate dal pieno per personalizzare lo stile della tua California.

Special washers made of billet aluminium to personalize the style of your California.



**PEDANE PILOTA
PILOT FOOTBOARDS**

.....
COD. B064249

Pedane pilota reclinabili realizzate in alluminio ricavato dal pieno lucidate a specchio, mantengono la stessa ergonomia di guida di quelle di serie ma offrono un design alleggerito e personalizzato in linea con lo stile della moto.

Reclining rider footpegs made of high-gloss polished billet aluminium, they maintain the same driving ergonomics like the standard ones, but offer a light-weight and customized design in line with the style of the motorcycle.



**PEDANE PASSEGGERO RIPIEGABILI
PASSENGER FOOTBOARDS**

.....
COD. B064248

Realizzate in alluminio ricavato dal pieno lucidate a specchio. Mantengono lo stesso design delle pedane pilota. Regolabili orizzontalmente in 4 posizioni attraverso un meccanismo a molla che facilita il loro posizionamento ottimale.

Made of high-gloss polished billet aluminium. Maintain the same design of the rider footpegs. Horizontally adjustable in 4 positions thanks to a spring mechanism that makes the ideal positioning very easy.





**SELLA PILOTA COMFORT GEL
COMFORT GEL PILOT SADDLE**

.....
COD. 2S000603

Questa sella presenta un inserto in gel nella zona della seduta che garantisce comodità e riduzione delle vibrazioni. La copertura presenta la punzonatura del logo "COMFORT Gel".
This saddle has a gel inserted on the seating area that ensures comfort and reduction in vibration. The "COMFORT Gel" logo is punched on the cover.



**SELLA PASSEGGERO COMFORT GEL
COMFORT GEL PASSENGER SADDLE**

.....
COD. 2S000605

Questa sella presenta un inserto in gel nella zona della seduta che garantisce comodità e riduzione delle vibrazioni. La copertura presenta la punzonatura del logo "COMFORT Gel".
This saddle has a gel inserted on the seating area that ensures comfort and reduction in vibration. The "COMFORT Gel" logo is punched on the cover.



**FASCIA PER BORSA SERBATOIO
IN PELLE
LEATHER TANK COVER**

.....
COD. 2S000524

Cover realizzata in pelle che segue perfettamente il profilo del serbatoio e permette di montare la borsa dedicata.
Leather tank cover, perfectly matching with tank profile and allows to mount the dedicated tank bag.



**COPPIA BORSE LATERALI IN PELLE
BLACK LEATHER SIDE BAGS KIT**

.....
COD. 2S000526

Coppia di borse laterali in pelle nere con taglio classico, ciascuna di 23 lt, sono fissate ai telaietti con una serratura che ne impedisce la rimozione. Contengono una tracolla regolabile per il loro trasporto. Per il montaggio sono necessari i supporti laterali (cod. 2S000538).
Set of two Classic-cut black leather bags, 23 litres each, mounted on specific subframes equipped with a lock to prevent removal. They contain an adjustable shoulder strap for transport. Side brackets are needed for mounting (cod. 2S000538).



**BORSA MANUBRIO
HANDLEBAR BAG**

.....
COD. 2S000034

Elegante e funzionale borsa-manubrio realizzata in cordura e pelle naturale che incornicia il marchio Moto Guzzi, utile per contenere piccoli oggetti. La sua funzionalità è garantita dalla facile installazione e rimozione dal manubrio del veicolo.
Elegant and functional handlebar bag made of Cordura and natural leather with Moto Guzzi logo, useful to hold small items. Its functionality is guaranteed by the easy installation and removal from the vehicle handlebar.



**BORSA SERBATOIO IN PELLE
LEATHER TANK BAG**

.....
COD. 2S000525

Borsa in pelle, estensibile, dotata di pratiche tasche e di maniglia per il trasporto, si fissa al copriserbatoio tramite sganci rapidi e chiusura micrometrica. È dotata di cuffia anti-pioggia.
Extensible leather bag equipped with practical pockets and transport handle, fixed to the tank cover with quick release and micrometric closing. Includes rain cover.



**SUPPORTI LATERALI PER BORSE
BAGS SUPPORT**

.....
COD. 2S000538

Kit di montaggio per le borse laterali in cuoio (cod. 2S000526).
Mounting kit for the side leather bags (cod. 2S000526).



**SCARICHI OMOLOGATI
HOMOLOGATED MUFFLERS SET**

.....
COD. 2S000658 - MY16

Per sentire il ruggito di una vera moto custom: questi scarichi slip on sono omologati e presentano uno stile simile agli scarichi di serie ma con una finitura dedicata e fondello specifico.
To hear the roar of a real custom motorcycle: these slip on exhausts are approved and have a style similar to standard exhausts but with a dedicated finishing and specific ends caps.



**ALLARME ELETTRONICO
ELECTRONIC ALARM**

.....
COD. 2D000027

Sistema di allarme compatto radiocomandato e autoalimentato di ultima generazione. Tra le sue specifiche offre: blocco motore, sensore di spostamento integrato, elevato livello di protezione.

State of the art self-powered remote control compact alarm system. Its specifications include: engine block, built in motion sensor, high protection degree.



GUZZI MULTIMEDIA PLATFORM

.....
COD. 606522M

GMP è il nuovo dispositivo che consente di collegare il proprio Smartphone alla moto, trasformandola in una vera e propria piattaforma multimediale.

GMP is the new device that allows you to connect your smartphone to the motorcycle, turning it to a real multimedia platform.



**TELO COPRIMOTO
ELDORADO "EAGLE"
"EAGLE" ELDORADO BIKE COVER**

.....
COD. 606167M
COD. 606249M CON BAULE/WITH TOP BOX

Telo su misura da interno per la protezione dalla polvere da utilizzare durante le soste in garage della moto. È realizzato in un tessuto elasticizzato con grafica speciale.

Tailor-made motorcycle cover for inside to protect against dust, intended for inside use to protect against dust, intended to be used for long period of storing of the bike in a garage. It is made of stretch fabric with special graphics.



**KIT SUPPORTO USB
USB SOCKET KIT**

.....
COD. 2S000315

Preso USB fornita di supporto dedicato per installazione nel sottosella, per la ricarica dei supporti elettronici, non consente il dialogo con gli apparati elettronici del mezzo.

USB socket with bracket for installation under the saddle, to recharge the electronic media, does not allow dialogue with the electronic devices of the vehicle.



CALIFORNIA

1400 TOURING



MOTO GUZZI®



**PARABREZZA MEDIO
SUPPORTI RIBASSATI
MEDIUM WINDSHIELD
LOWER BRACKETS**

.....
COD. 2S000544

Parabrezza di misura media con la lastra in Lexan antiurto e antigraffio. Omologato secondo le normative DOT. Si monta facilmente grazie ai supporti ribassati da acquistare separatamente. H44 x L52 cm.

Medium sized windshield with shockproof and scratch resistant Lexan sheet. Approved according to the DOT standards. It is easy to mount due to its lowered brackets, to be purchased separately. H44 x L52 cm.



**PARABREZZA SPORT
SUPPORTI RIBASSATI
SPORT WINDSHIELD
LOWER BRACKETS**

.....
COD. 2S000548

Parabrezza di misura particolarmente ridotta con la lastra in Lexan antiurto e antigraffio, che mantiene nel tempo inalterate le caratteristiche di trasparenza e lucentezza. Omologato secondo le normative DOT. Si monta facilmente grazie ai supporti ribassati da acquistare separatamente. H34 x L41 cm.

Specially reduced sized windshield with shockproof and scratch resistant Lexan sheet, maintaining the transparency and gloss characteristics unaltered over time. Approved according to the DOT standards. It is easy to mount due to its lowered brackets, to be purchased separately. H34 x L41 cm.



**SUPPORTI PARABREZZA
RIBASSATI
WINDSHIELD LOWER BRACKETS**

.....
COD. 2S000542

Robusto kit di fissaggio, a misura ridotta, dotato di supporti specifici per il montaggio del parabrezza. Necessita delle minuterie 606255M.

Small sized solid fastening kit, equipped with specific brackets for mounting the windshield. Requires 606255M small metallic parts.



**PARABREZZA MEDIO
SUPPORTI STANDARD
MEDIUM WINDSCREEN
STANDARD BRACKETS**

.....
COD. 2S000546

Parabrezza di misura media con la lastra in Lexan antiurto e antigraffio, che mantiene nel tempo inalterate le caratteristiche di trasparenza e lucentezza. Omologato secondo le normative DOT. Si monta facilmente grazie ai supporti standard da acquistare separatamente. H44 x L52 cm.

Medium sized windshield with shockproof and scratch resistant Lexan sheet, maintaining the transparency and gloss characteristics unaltered over time. Approved according to the DOT standards. Can be easily mounted due to the standard brackets, to be purchased separately. H44 x L52 cm.



**DEFLETTORI ARIA PARABREZZA
WINDSHIELD AIR DEFLECTORS**

.....
COD. B064235

Appendici da applicare nella zona sottostante al parabrezza per aumentare la protezione ed il comfort di guida offerti al pilota.

Attachments to be applied under the windshield to increase rider's protection and driving comfort.



**PARABREZZA GRANDE
SUPPORTI STANDARD
WIDE WINDSCREEN
STANDARD BRACKETS**

.....
COD. 2S000547

Parabrezza di misura grande con la lastra in Lexan antiurto e antigraffio. Omologato secondo le normative DOT. Si monta facilmente grazie ai supporti standard da acquistare separatamente. H70 x L59 cm.

Large sized windshield with shockproof and scratch resistant Lexan sheet. Approved according to the DOT standards. Can be easily mounted due to the standard brackets, to be purchased separately. H70 x L59 cm.



**LEVA FRIZIONE
CLUTCH LEVER**

.....
COD. 606452M

Speciale leva della frizione regolabile realizzata in alluminio, ricavata dal pieno con design personalizzato e con finitura antigraffio lucida.

Special adjustable clutch lever made of billet aluminium, with custom design and glossy scratch resistant finishing.



**LEVA FRENO
BRAKE LEVER**

.....
COD. 606453M

Speciale leva del freno regolabile realizzata in alluminio, ricavata dal pieno con design personalizzato e con finitura antigraffio lucida.

Special adjustable brake lever made of billet aluminium, with custom design and glossy scratch resistant finishing.



**SPECCHIETTI RETROVISORI
MIRRORS**

.....
COD. B064245

Speciali specchietti retrovisori omologati realizzati in alluminio ricavati dal pieno con finitura antigraffio lucida.

Special approved rear-view mirrors made of billet aluminium with glossy scratch resistant finishing.



**SPECCHIETTI RETROVISORI NERI
BLACK MIRRORS**

.....
COD. 2S000031

Speciali specchietti retrovisori omologati realizzati in alluminio ricavato dal pieno con finitura nera.

Special approved rear-view mirrors made of billet aluminium with black finishing.



**COPERCHIO POMPA
FRENO E FRIZIONE
BRAKE AND CLUTCH RESERVOIR
COVER**

.....
COD. B064259

Speciali coperchi delle pompe freno e frizione realizzati in alluminio ricavati dal pieno con finitura antigraffio lucida.

Special covers for brake and clutch pumps made from billet aluminium with glossy scratch resistant finishing.



**MANOPOLE IN ALLUMINIO
ALUMINIUM HANDGRIPS**

.....
COD. B064257 - MY16

Speciali manopole realizzate in alluminio ricavate dal pieno con inserti anti scivolo in gomma e finitura lucida.

Special billet aluminium handlebars with rubber non-skid inserts and glossy finishing.



**MANOPOLE RISCALDATE
HEATED HANDGRIPS**

.....
COD. B064270 - MY16

Per chi ama viaggiare a lungo in tutte le stagioni, facilmente installabili grazie alla predisposizione presente su tutte le California. Contribuiscono al comfort di guida, evitando che le mani possano indolenzirsi a causa del freddo.

For those who love travelling in all seasons, easily mountable due to the arrangement on all California. They contribute to the driving comfort, preventing hand stiffening because of the cold.



**SUPPORTO GPS
GPS BRACKET**

.....
COD. B064243

Supporto realizzato in acciaio inox lucido con predisposizione per il montaggio del navigatore satellitare.

Bracket made of glossy stainless steel with arrangement for mounting the satellite navigator.



**COVER CLacson IN ALLUMINIO
ALUMINIUM HORNS COVER**

.....
COD. 2S000466 - MY16

Cover in alluminio ricavato dal pieno, si applica ai clacson per dare un look sportivo alla moto.

The billet aluminium cover is applied to the horns giving the motorcycle a sportive look.



**MANUBRIO TOURING CROMATO NERO
BLACK CHROMED HANDLEBAR TOURING**

.....
COD. B064246 - MY16

Per una personalizzazione esclusiva della propria moto, sviluppato dai collaudatori Moto Guzzi, il manubrio cromato nero consente di mantenere la posizione di guida ottimale per il controllo della moto. Da oliare periodicamente per proteggere e mantenere lucida la cromatura.

For an exclusive customization of your motorcycle, developed by the Moto Guzzi testers, the black chrome handlebar keeps the optimum driving position for the control of the motorcycle. To be oiled regularly to protect and maintain the gloss of the chromium coating.



**COPRI STELI FORCELLA
FORK SLEEVE COVERS**

.....
COD. B064252

I copri steli forcella con finitura cromata si abbinano agli altri elementi in alluminio, già presenti sul veicolo, per esaltare le zone laterali.

The fork sleeve covers with chrome finishing match the other aluminium elements, already mounted on the vehicle, to enhance the side areas.



**CORNICE RADIATORE OLIO
OIL RADIATOR FRAME SET**

.....
COD. 2S000349 - MY16

Realizzato in alluminio lucidato tagliato al laser, completo di rete protettiva, si applica al radiatore conferendo un look classico e raffinato.

Made in polished laser-cut aluminium, completed with protective grid, it is applied to the radiator giving a classic and stylish look.





**GUANCIALI SERBATOIO CROMATI
CHROMED TANK COVERS**

.....
COD. B064244

Le cover laterali del serbatoio cromate personalizzano lo stile della moto rendendola una vera «fuoriserie».

The side tank covers, made of steel with chromed finish, customize the style of the motorcycle, making it a "custom-built" vehicle.



**COPRI INIETTORI
INJECTOR COVERS**

.....
COD. B064253

La coppia di copri iniettori realizzati in alluminio con finitura spazzolata sostituisce quella di serie, assicurando alla moto un look più ricco, più curato e coerente con le parti in alluminio già presenti.

The injector covers made of aluminium with brushed finishing replaces the standard one, providing the motorcycle with a richer, refined and consistent look with the aluminium parts already mounted.



**PARACALORE CILINDRI
THERMAL PROTECTION SET**

.....
COD. 2S000032

Ogni paracalore è realizzato in acciaio inox lucidato a specchio, con inserti in abs che migliorano il design ed attenuano il contatto delle ginocchia con il motore. Proteggono dal calore generato dal cilindro, per una guida più sicura e confortevole.

Each heat shield is made from high-gloss polished stainless steel, with abs inserts improving design and reducing the contact of the knees with the engine. They protect from the heat generated by the cylinder, for a more secure and comfortable driving.



**SELLA IN PELLE TOURING
TOURING LEATHER SADDLE**

.....
COD. B064237

Per chi ricerca una finitura di lusso che sposi lo stile pregiato offerto dalla moto è disponibile una sella rivestita in vera pelle da artigiani specializzati.

For those looking for a luxurious finishing matching the refined style offered by the motorcycle, a saddle covered with true leather by skilled artisans.



**SET BUSSOLE TESTATA IN ALLUMINIO
ALUMINIUM HEAD BUSHINGS SET**

.....
COD. 2S000348

Set di quattro distanziali in alluminio ricavato dal pieno, da montare in sostituzione delle viti che fissano le cover delle teste cilindro. Le viti a corredo sono in acciaio inox lucidato.

Set of four aesthetic spacers made from billet aluminium, to be mounted in place of the screws that hold the cover of the cylinder head. The screws supplied with the kit are made of polished stainless steel.



**PROTEZIONE TESTE
CYLINDER COVERS PROTECTION**

.....
COD. B064247

Speciali protezioni laterali cilindri realizzate in alluminio ricavato dal pieno finite con la lucidatura a specchio. Si integrano perfettamente con lo stile ed il design della moto. Complete di supporti in acciaio inox lucidati a specchio.

Special cylinder side shields made from billet aluminium, finished with high-gloss polishing. They perfectly match with style and design of the motorcycle. Provided with high-gloss polished stainless steel brackets.



**SELLA COMFORT TOURING
TOURING COMFORT SADDLE**

.....
COD. B064236

Comfort offerto a pilota e passeggero grazie agli inserti in gel ricavati nelle zone di seduta. Materiale bicolore in linea con l'allestimento top della moto. Dicitura "comfort gel" punzonata in rilievo. Stessa altezza della sella di serie.

Comfort for the driver and passenger thanks to the gel inserts in the saddle. Bi-coloured material in line with the top equipment of the motorcycle. "Comfort gel" text engraved in relief «comfort gel». Same height as the standard series.



**COVER SERBATOIO OLIO FRENO
POSTERIORE
REAR BRAKE RESERVOIR COVER**

.....
COD. B064288

Realizzato in alluminio ricavato dal pieno, con una finitura lucida, personalizza il look del veicolo. Ricopre completamente il corpo del serbatoio olio freno lasciando inalterate le funzionalità. È di facile installazione.

Made from billet aluminium, with a polished finish, it customizes the look of the vehicle. Covers completely the body of the brake oil tank, without altering the functions. Easy to mount.



**PEDANE PILOTA
PILOT FOOTRESTS**

.....
COD. B064249

Pedane pilota reclinabili realizzate in alluminio ricavato dal pieno lucidate a specchio, mantengono la stessa ergonomia di guida di quelle di serie ma offrono un design alleggerito e personalizzato in linea con lo stile della moto.

Reclining rider footpegs made of high-gloss polished billet aluminium, they maintain the same driving ergonomics like the standard ones, but offer a light-weight and customized design in line with the style of the motorcycle.



**PEDANE PASSEGGERO
PASSENGER FOOTRESTS**

.....
COD. B064248

Realizzate in alluminio ricavato dal pieno lucidate a specchio. Mantengono lo stesso design delle pedane pilota. Regolabili orizzontalmente in quattro posizioni attraverso un meccanismo a molla che facilita il loro posizionamento ottimale.

Made of high-gloss polished billet aluminium. Maintain the same design of the rider footpegs. Horizontally adjustable in four positions by means of the spring mechanism that facilitates their ideal positioning.



**ROSETTE FORCELLONE
SWINGARM WASHERS**

.....
COD. B064272

Rosette speciali realizzate in alluminio ricavate dal pieno per personalizzare lo stile della tua California.

Special washers made of billet aluminium to personalize the style of your California.



**BORSA MANUBRIO
HANDLEBAR BAG**

.....
COD. 2S000034

Elegante e funzionale borsa-manubrio realizzata in cordura e pelle naturale che incornicia il marchio Moto Guzzi, utile per contenere piccoli oggetti. La sua funzionalità è garantita dalla facile installazione e rimozione dal manubrio del veicolo.

Elegant and functional handlebar bag made of Cordura and natural leather with Moto Guzzi logo, useful to hold small items. Its functionality is guaranteed by the easy installation and removal from the vehicle handlebar.



**COPRI SERBATOIO
TANK COVER**

.....
COD. 2S000038

Realizzato in Cordura con inserti in pelle, permette di montare la borsa serbatoio dedicata.

Made of Cordura with leather inserts, allows mounting the dedicated tank bag.



**BORSA SERBATOIO
TANKBAG**

.....
COD. 2S000039

Borsa in Cordura con inserti in pelle, estensibile, dotata di pratiche tasche e di maniglia per il trasporto, si fissa al copri serbatoio tramite sganci rapidi e chiusura micrometrica. È dotata di cuffia antipioggia.

Extensible Cordura bag with leather inserts, equipped with practical pockets and transport handle, applied to the tank cover by quick release clamps and micrometric closing. Includes rain cover.



**PORTAPACCHI
REAR RACK**

.....
COD. B063992

Disegnato in tubo cromato dal Centro Stile Moto Guzzi, questo portapacchi amplia la capacità di carico della moto consentendo il montaggio dei bauli accessorio dedicati grazie alle apposite predisposizioni di fissaggio.

Designed in chrome tube by Centro Stile Moto Guzzi, it expands the load capacity of the motorcycle, allowing to mount dedicated accessory cases thanks to the special fixing arrangements.



**BAULETTO 50 lt CON CUSCINO
50 LT TOP BOX**

.....
COD. CM228501 NERO/BLACK
COD. CM228502 BIANCO/WHITE

Baule da 50 lt. a sgancio rapido, può ospitare 2 caschi integrali. Guscio superiore verniciato in tinta veicolo, dotato di schienalino. Necessita di portapacchi B063992.

50 litres box with quick release system, can hold 2 flip up helmets. Upper cover painted in the same colour as the vehicle, equipped with backrest. Requires luggage carrier B063992.





BORSE INTERNE PER VALIGIE LATERALI
INNER BAGS FOR SIDE CASES

.....
COD. B064250

Costruite nella stessa forma delle valigie che le contengono, possono essere staccate e trasportate facilmente. Set realizzato con materiali altamente performanti e tecniche innovative che ne garantiscono impermeabilità e resistenza.

Designed with the same shape of the cases containing them, they can be easily removed and carried. Set made of high-performance materials and innovative techniques guaranteeing water tightness and resistance.



BORSE RIVESTITE IN PELLE
LEATHER SIDE CASES

.....
COD. B064239

Disegnate dal Centro Stile Moto Guzzi, rivestite in pelle naturale da artigiani specializzati. Realizzate a mano, sposano la linea originale della moto offrendo una personalizzazione ricercata, utilizzando pellami italiani di pregio.

Designed by the Moto Guzzi Style Centre, coated with natural leather by skilled artisans. Manually crafted, they match the original line of the motorcycle, offering a refined personalized aspect, using prestigious Italian leathers.



ALLARME ELETTRONICO
ELECTRONIC ALARM

.....
COD. 2D000027

Sistema di allarme compatto radiocomandato e autoalimentato di ultima generazione. Tra le sue specifiche offre: blocco motore, sensore di spostamento integrato, elevato livello di protezione.

State of the art self-powered remote control compact alarm system. Its specifications include: engine block, built in motion sensor, high protection degree.



GUZZI MULTIMEDIA PLATFORM

.....
COD. 606522M

GMP è il nuovo dispositivo che consente di collegare il proprio Smartphone alla moto, trasformandola in una vera e propria piattaforma multimediale.

GMP is the new device that allows you to connect your smartphone to the motorcycle, turning it to a real multimedia platform.



BAULE 65 Lt CON CUSCINO
65 LT TOP CASE

.....
COD. CM262801 NERO/BLACK - MY17
COD. CM262805 ROSSO/RED - MY17
COD. CM262802 BIANCO/WHITE
COD. CM262803 MARRONE/BROWN
COD. CM262804 GRIGIO/GREY

Baule in vetroresina da 65 lt, verniciato in tinta veicolo con serrature cromatiche. Interno rifinito in vellutino, è dotato di specchio, rete salvaogetti e pistone, che lo rendono funzionale e piacevole. Necessita di portapacchi B063992.

65 litre fibreglass top box, painted in the vehicle color, with chrome locks. Velvet inner lining with inner mirror, object holder net and piston that render it functional and agreeable. Requires rear rack B063992.



SCARICHI OMOLOGATI
HOMOLOGATED MUFFLERS SET

.....
COD. 2S000658 - MY16

Per sentire il ruggito di una vera moto custom: questi scarichi slip on sono omologati e presentano uno stile simile agli scarichi di serie ma con una finitura dedicata e fondello specifico.

To hear the roar of a true custom motorcycle: these slip on exhausts are approved and have a style similar to standard exhausts but with a dedicated finishing and specific back cover.



KIT SUPPORTO USB
USB SOCKET KIT

.....
COD. 2S000315

Preso USB fornita di supporto dedicato per installazione nel sottosella, per la ricarica dei supporti elettronici, non consente il dialogo con gli apparati elettronici del mezzo.

USB socket with bracket for installation under the saddle, to recharge the electronic media, does not allow dialogue with the electronic devices of the vehicle.



TELO COPRIMOTO TOURING
TOURING BIKE COVER

.....
COD. B064241

Telo su misura da interno per la protezione dalla polvere da utilizzare durante le soste in garage della moto. È realizzato in un tessuto elasticizzato bicolore con grafica dedicata.

Tailor-made motorcycle cover for inside to protect against dust, intended for use during long periods of storing the bike in a garage. It is made from an elasticised bi-coloured fabric with dedicated graphics.





**TELO COPRIMOTO TOURING
CON BAULE
TOURING BIKE COVER
WITH TOP BOX**

.....
COD. B064242

Telo su misura da interno per la protezione dalla polvere da utilizzare durante le soste in garage della moto. È realizzato in un tessuto elasticizzato bicolore con grafica dedicata.

Tailor-made motorcycle cover for inside to protect against dust, intended for use during long periods of storing the bike in a garage. It is made from an elasticised bi-coloured fabric with dedicated graphics.







MOTO GUZZI®

— **APPAREL** —



OTO GUZZI

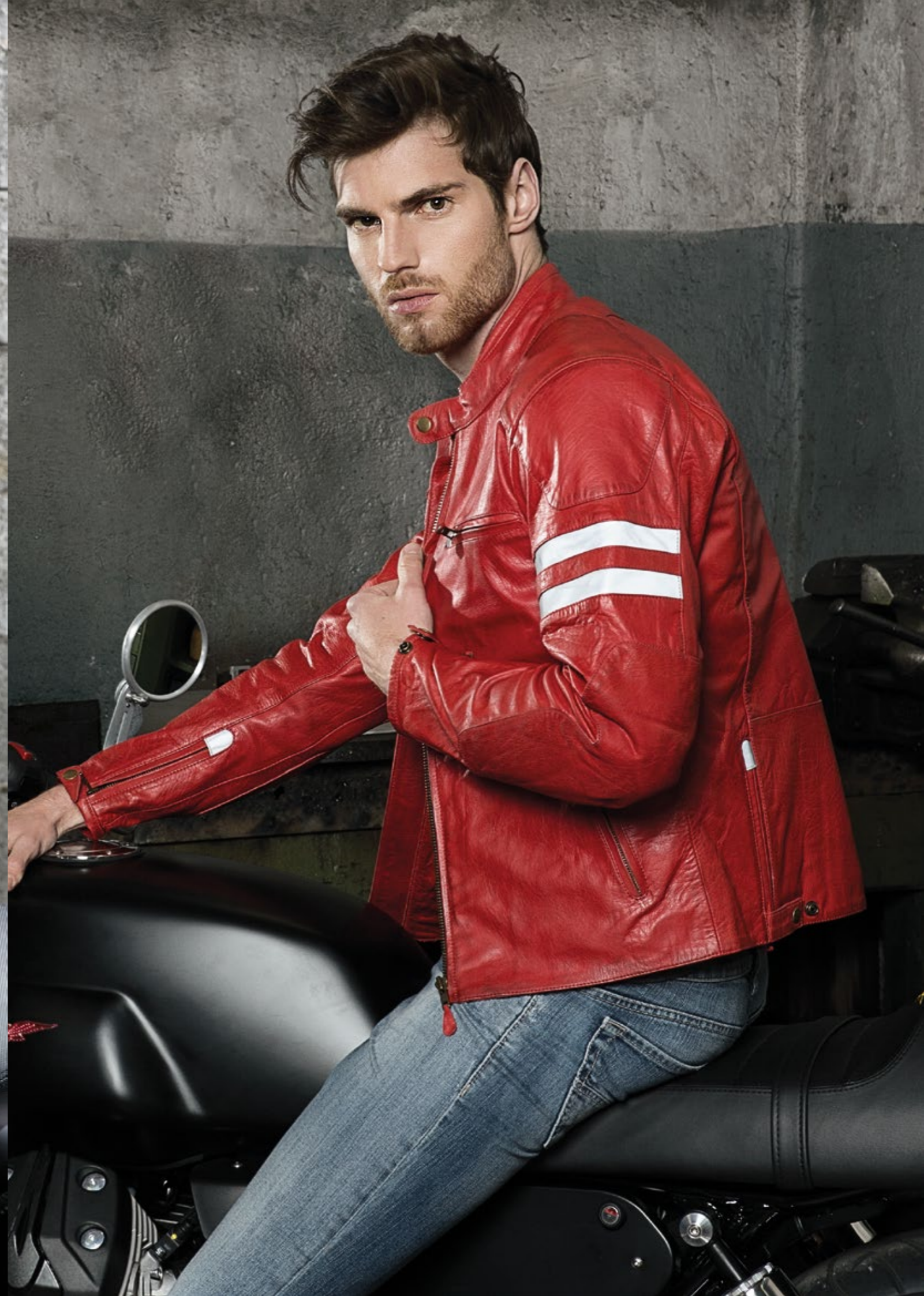













PROUDLY



AUTHENTIC



MOTORCYCLES.



SINCE 1921



MOTO GUZZI





**CASCHI
HELMETS**



La grande tradizione motociclistica, la cura nei dettagli e l'utilizzo di materiali ricercati dalla elevata qualità si sintetizza nella nuova linea di caschi Moto Guzzi. Caschi progettati per garantire il massimo livello di protezione ed una ricercata cura del design per offrire dei modelli dalla forte personalità. Grande attenzione anche all'utilizzo di grafiche dal forte contenuto emozionale in grado di enfatizzare la Storia e l'heritage di Moto Guzzi (dal tricolore, alle grafiche racing tipiche degli anni '30).

The great motorcycling tradition, the attention to detail and use of high quality materials are present in the new range of Moto Guzzi helmets. They have been designed to ensure the highest level of protection and design in order to provide objects with a strong personality. It has been set great attention to the use of graphics with strong emotional content, they emphasize the history and heritage of Moto Guzzi (the three-tone flag, the typical of the '30s racing graphics).

US customers are advised to ask the local dealer for DOT helmets part numbers.

**MASK
CASCHI / HELMETS**

Il casco Mask è dotato di uno stile unico, grazie alla calotta in materiale termoplastico ad alta resistenza, ai goggles con doppie lenti Carl Zeiss®, ed alla mascherina rimovibile. Gli Interni sono lavabili, trattati con carboni attivi. Grande sicurezza ed un look inconfondibile sono la combinazione perfetta alla guida della vostra Moto Guzzi.

Mask helmet has a unique style thanks to the thermoplastic Hi resistance shell, Double anti-fog / anti-scratch goggles developed by Carl Zeiss, and removable mask. Removable Interior bamboo liner can be washed. High safety and unmistakable look are the perfect combination to ride your Moto Guzzi



NERO/BLACK

XS	606364M01S
S	606364M02S
M	606364M03S
L	606364M04S
XL	606364M05S

**RACING 29
CASCHI / HELMETS**



Calotta fibra di vetro, qualità nei dettagli e nelle finiture.
Visiera parasole corta a scomparsa, cinturino con chiusura micrometrica.
Interni estraibili traspiranti e lavabili.
Made in Italy.
Omologazione ECE 22.05.
Fiberglass shell, high quality and accurate details. Retractable Sun Visor. Micrometric retention system. Washable, removable and breathable Linninig Made in Italy.
ECE 22.05. omologation



CROMO/CHROME

XS	606069M01RC
S	606069M02RC
M	606069M03RC
L	606069M04RC
XL	606069M05RC



ROSSO/RED

XS	606070M01RR
S	606070M02RR
M	606070M03RR
L	606070M04RR
XL	606070M05RR

MATT BLACK
CASCHI / HELMETS

Calotta fibra di vetro, qualità nei dettagli e nelle finiture.
Visiera parasole corta a scomparsa, cinturino con chiusura micrometrica. Interni estraibili traspiranti e lavabili.
Made in Italy.
Omologazione ECE 22.05.

Fiberglass shell, high quality and accurate details. Retractable Sun Visor. Micrometric retention system. Washable, removable and breathable Linninig
Made in Italy.
ECE 22.05. omologation



NERO/BLACK

XS	606071M01B
S	606071M02B
M	606071M03B
L	606071M04B
XL	606071M05B

ITALIAN PRIDE
CASCHI / HELMETS

Calotta fibra di vetro, qualità nei dettagli e nelle finiture.
Visiera parasole corta a scomparsa, cinturino con chiusura micrometrica.
Interni estraibili traspiranti e lavabili.
Made in Italy.
Omologazione ECE 22.05.

Fiberglass shell, high quality and accurate details. Retractable Sun Visor. Micrometric retention system. Washable, removable and breathable Linninig
Made in Italy.
ECE 22.05. omologation



ARGENTO/SILVER

XS	606073M01IP
S	606073M02IP
M	606073M03IP
L	606073M04IP
XL	606073M05IP

STRIPES
CASCHI / HELMETS

Calotta fibra di vetro, qualità nei dettagli e nelle finiture.
Visiera parasole corta a scomparsa, cinturino con chiusura micrometrica.
Interni estraibili traspiranti e lavabili.
Made in Italy.
Omologazione ECE 22.05.

Fiberglass shell, high quality and accurate details. Retractable Sun Visor. Micrometric retention system. Washable, removable and breathable Linninig
Made in Italy.
ECE 22.05. omologation



BIANCO/WHITE

XS	606074M01WS
S	606074M02WS
M	606074M03WS
L	606074M04WS
XL	606074M05WS



NERO/BLACK

XS	606072M01BS
S	606072M02BS
M	606072M03BS
L	606072M04BS
XL	606072M05BS

DECAL
CASCHI / HELMETS



Casco Jet in ABS.
Colori: giallo, bianco lucido e rosso in perfetta armonia con verniciatura e grafica V9.
Rifiniture calotta ed interno in morbida pelle con bandierina tricolore sul bordo inferiore sinistro.
Interni anallergici.
Taglie: da XS a XL.
Made in Italy.
Omologazione: secondo le normative: ECE 22.05.

*Jet helmet with ABS shell.
Colours: Gloss yellow, white and red to complement the V9 paint schemes.
Premium soft leather trim and lining with tricolor flag detail on lower left edge.
Hypoallergenic lining.
ECE 22.05 approved.
Sizes: from XS to XL.
Made in Italy.*



GIALLO LUCIDO
.....

XS	606413M01YL
S	606413M02YL
M	606413M03YL
L	606413M04YL
XL	606413M05YL



BIANCO/WHITE
.....

XS	606413M01W
S	606413M02W
M	606413M03W
L	606413M04W
XL	606413M05W

DECAL
CASCHI / HELMETS



ROSSO/RED
.....

XS	606413M01R
S	606413M02R
M	606413M03R
L	606413M04R
XL	606413M05R

CHESSE
CASCHI / HELMETS



Casco Jet in ABS.
Colori: giallo opaco e grigio spazzolato in perfetta armonia con verniciatura e grafica del veicolo.
Rifiniture calotta ed interno in morbida pelle con bandierina tricolore sul bordo inferiore sinistro.
Interni anallergici.
Taglie: da XS a XL.
Made in Italy.
Omologazione: secondo le normative: ECE 22.05.

*Jet helmet with ABS shell.
Colours: Matt yellow and brushed grey to complement the V9 Bobber paint schemes.
Premium soft leather trim and lining with tricolor flag detail on lower left edge.
Hypoallergenic lining.
Sizes: from XS to XL.
Made in Italy.
ECE 22.05 approved.*



GIALLO OPACO
.....

XS	606412M01YO
S	606412M02YO
M	606412M03YO
L	606412M04YO
XL	606412M05YO



GRIGIO/GREY
.....

XS	606412M01G
S	606412M02G
M	606412M03G
L	606412M04G
XL	606412M05G

V7 III SPECIAL
CASCHI / HELMETS



Calotta Jet in ABS.
Logo MG verniciato in tinta serbatoio e stampato a caldo su pelle passa occhiali.
Bordatura in ecopelle cucita direttamente sulla calotta.
Rivestimento interno in tessuto anallergico.
Made in Italy
ECE 22.05

*ABS Jet shell.
Moto Guzzi Logo in same painting of the vehicle tank & embroidered on the leather google holder on the rear part of the shell.
Ecoleather edge stitched on the shell.
Hypoallergenic lining.
Made in Italy
ECE 22.05*



AZURE
.....

XS	606619M01AZ
S	606619M02AZ
M	606619M03AZ
L	606619M04AZ
XL	606619M05AZ



BLACK
.....

XS	606619M01BK
S	606619M02BK
M	606619M03BK
L	606619M04BK
XL	606619M05BK

V7 ANNIVERSARIO
CASCHI / HELMETS



Calotta Jet in ABS.
Logo MG stampato a caldo color oro su pelle passa occhiali e fascia pelle centrale abbinata alla sella.
Bordatura in pelle cucita direttamente sulla calotta.
Targhetta dedicata V7 Anniversario.
Rivestimento interno in tessuto anallergico.
Made in Italy.
Omologazione ECE 22.05

ABS Jet shell.
Gold Moto Guzzi Logo embroidered on the leather google holder and on the central leather band matching with veicle seat.
Leather edge stitched on the shell.
Dedicated V7 Anniversary plate.
Hipoallergenic lining.
Made in Italy.
ECE 22.05 Homologation.



NERO/BLACK

XS	606620M01MB
S	606620M02MB
M	606620M03MB
L	606620M04MB
XL	606620M05MB

JET SCRATCH
CASCHI / HELMETS



Calotta Jet in ABS.
Colore cromo graffiato acciaio.
Made in Italy.
Bordatura in ecopelle cucita direttamente sulla calotta.
Rivestimento interno in tessuto anallergico.
Omologazione ECE 22.05.

ABS Shell
Chrome Scratch colour.
Made in Italy.
Ecoleather bordering directly sewed onto the shell.
Internal abtibacterial lining
ECE 22.05 omologation



CROMO/CHROME

S	606219M02S
M	606219M03S
L	606219M04S
XL	606219M05S

**THE CLAN
CASCHI / HELMETS**



Casco Jet in ABS.
Rifiniture calotta ed interno in morbida pelle color tabacco.
Interni anallergici in materiale premium.
Sistema di ritenzione con sgancio micrometrico.
Taglie: da XS a XL.
Made in Italy.
Omologazione: secondo le normative: ECE 22.05.

*Jet helmet with ABS shell.
Premium soft leather trim and lining.
Hypoallergenic lining.
Micrometric retention system.
Sizes: from XS to XL.
Made in Italy.
ECE 22.05 approved.*



NERO/BLACK

XS	606361M01C
S	606361M02C
M	606361M03C
L	606361M04C
XL	606361M05C

**VISIERA
VISOR**



TRASPARENTE/TRANSPARENT
.....
COD. 606414M



FUMÈ
.....
COD. 606415M

**MASCHERA IN PELLE
GOGGLES**

Maschera in pelle Moto Guzzi.
Rifinite nei minimi particolari.
Disponibili in due colorazioni,
nere e marroni, entrambe con lenti
azzurre per attenuare i raggi UV.

*Moto Guzzi Vintage Rider
Refined in every small detail.
Available in two colors, black and
brown, both with blue lenses to
attenuate UV rays.*



NERO/BLACK
.....
COD. 606009M001



MARRONE/BROWN
.....
COD. 606009M002

**OCCHIALI MOTO GUZZI
MOTO GUZZI SUNGLASSES**

Gli occhiali Moto Guzzi sono una riedizione del classico modello vintage a goccia in chiave moderna, il colore nero opaco e le lenti specchio sfumate lo rendono elegante e sportivo allo stesso tempo.

Caratteristiche:
montatura in materiale Tr90; lenti infrangibili Cr39; montatura colore nero opaco; lenti grigio/verde specchio sfumate.

*Moto Guzzi sunglasses are a remake of the classic drop shape vintage model into a modern version.
Matt black color and gradient mirror lenses make it elegant and sporty at the same time.*

Features:
frame material Tr90; shatterproof lenses CR39; rame matt black, lenses in grey/green gradient mirror.



NERO/BLACK
.....
COD. 606235M

GIACCA PELLE LEATHER JACKET

Le nuove giacche in pelle Moto Guzzi sono state disegnate specificatamente sia per uomo che per donna. Sono giacche tecniche per l'utilizzo in moto, quindi sono presenti gli appositi alloggiamenti per le protezioni omologate CE spalle e gomiti (incluse) e quella per la protezione schiena, che sceglie il cliente. Sono confezionate con pellami bovini di alta qualità e sono le più leggere e morbide sul mercato. Hanno subito un trattamento estetico che le rende "usate", subito perfettamente vestibili e comodissime. Queste giacche, offrono imbottiture esterne sia estetiche che funzionali su spalle e gomiti, hanno cerniere di regolazione ai fianchi, 4 tasche esterne e inserti rifrangenti 3M. Contengono anche un gilet asportabile imbottito, trapuntato, anche questo con tasca. Sia le giacche uomo che donna, sono previste in 4 colori: nero, blu, cielo, rosso e nelle seguenti taglie: S-XXXL uomo ; S-XL donna.



NERO/BLACK
.....
UOMO / MAN

S	606466M00N
M	606466M01N
L	606466M02N
XL	606466M03N
XXL	606466M04N

ROSSO/RED
.....
UOMO / MAN

M	606092M01R
L	606092M02R
XL	606092M03R
XXL	606092M04R

BLU/BLUE
.....
UOMO / MAN

M	606092M01B
L	606092M02B
XL	606092M03B
XXL	606092M04B

AZZURRO SKY/SKY BLUE
.....
UOMO / MAN

M	606092M01A
L	606092M02A
XL	606092M03A
XXL	606092M04A

NEW XXXL 606466M05N



New Guzzi's leather jackets are designed and engineered specifically for man and woman. It's a range of technical apparel for motorcycle use, so these jackets are equipped with pockets for shoulders and elbows protectors (CE protectors included) and backprotector (optional, to be selected by the user). The deep leather treatment gives to these jackets a genuine used look, easy fitting and makes these jackets very comfortable. Outside, we find aesthetical and functional quilting on shoulders and elbows, adjusting zipper, 4 external pockets, reflecting 3m scotchlite inserts. Inside the jacket you can find a removable quilted thermal vest. Both, men's and women's models are made in 4 colours: black, navy, sky, red. Men sizes S - XXXL Women sizes S - XL.



NERO/BLACK
.....
DONNA / WOMAN

S	606093M00N
M	606093M01N
L	606093M02N
XL	606093M03N

ROSSO/RED
.....
DONNA / WOMAN

S	606093M00R
M	606093M01R
L	606093M02R
XL	606093M03R

BLU/BLUE
.....
DONNA / WOMAN

S	606093M00B
M	606093M01B
L	606093M02B
XL	606093M03B

AZZURRO SKY/SKY BLUE
.....
DONNA / WOMAN

S	606093M00A
M	606093M01A
L	606093M02A
XL	606093M03A



GIACCA PELLE CHiodo
CHiodo LEATHER JACKET

Lo stile inconfondibile del "CHiodo" in pelle in questa edizione Moto Guzzi viene esaltata dall'estrema cura nella selezione del materiale (una pelle d'agnello nappata) e dall'attenzione dedicata ai dettagli come le cerniere nichelate ed i bottoni a pressione con il logo dell'Aquila laserato. Un look forte e deciso con una vestibilità avvolgente e confortevole, rendono questo capo ideale non solo alla guida della vostra Moto Guzzi, ma anche nella vita quotidiana.

The unmistakable style of this "CHiodo" leather jacket, in this Moto Guzzi edition, emphasize the extreme care in material selection (nappa lamb leather) and the attention in details like Nickel-plated zippers and snap buttons with lasered Eagle Logo. A strong look combined with a tight but comfortable fit, makes this jacket the perfect apparel not only to ride your Moto Guzzi, but also for daily life.

NERO/BLACK

.....
 UOMO / MAN

S	606468M00B
M	606468M01B
L	606468M02B
XL	606468M03B
XXL	606468M04B
XXXL	606468M05B

NERO/BLACK

.....
 DONNA / WOMAN

S	606469M00B
M	606469M01B
L	606469M02B
XL	606469M03B

GIACCA TOURING
TOURING JACKET
 UOMO / MAN

NERO/BLACK

.....

S	605797M022
M	605797M032
L	605797M042
XL	605797M052
XXL	605797M062
XXXL	605797M072

GIACCA IN TESSUTO
TEXTILE JACKET
 UOMO / MAN

Pratiche, funzionali, protettive e adatte ad ogni stagione. Queste giacche in tessuto tecnico, dotate di protezioni rimovibili spalle e gomiti, hanno un design originale e grande attenzione nella cura dei dettagli. *Versatile, functional, protective and for all season use, these textile jackets, with removable shoulders and elbows protectors, show an original design and great attention to every detail.*

GRIGIO/GREY

.....

M	606110M01G
L	606110M02G
XL	606110M03G
XXL	606110M04G

VINTAGE GREEN

.....

M	606110M01V
L	606110M02V
XL	606110M03V
XXL	606110M04V

GIACCA IN TESSUTO
TEXTILE JACKET
 DONNA / WOMAN

GRIGIO/GREY

.....

S	606111M00G
M	606111M01G
L	606111M02G

VINTAGE GREEN

.....

S	606111M00V
M	606111M01V
L	606111M02V

**MG ZIP
GUANTI / GLOVES**

Il modello "Stripes" ha due fasce riflettenti sul dorso e regolazione della chiusura sul polso in velcro. Il modello "Zip" ha invece cuciture a contrasto sul dorso e chiusura polso con Zip. Sono guanti Estivi, comodi, provvisti di rinforzo sul palmo ed inserti in silicone su indice e medio per un migliore controllo delle leve freno e frizione. Sono marchiati Moto Guzzi, all'interno del polso, con stampa oro.

4 Taglie Unisex S - XL

made in bovine full grain leather, very soft but tested for abrasion resistance. Both model are in black color: "Stripes" gloves show two reflective stripes on the top and Velcro wrist closure. "Zip" gloves have contrast stitching on top of the knuckles, with soft padding, and a Zipper wrist closure. Branded by a golden print Moto Guzzi logo, are made in 4 unisex sizes from S to XL

NERO/BLACK

S	606082M02Z
M	606082M03Z
L	606082M04Z
XL	606082M05Z

**MG STRIPES
GUANTI / GLOVES**

NERO/BLACK

S	606081M02S
M	606081M03S
L	606081M04S
XL	606081M05S

**WINTER TOURING
GUANTI / GLOVES**

Guanti misto pelle tessuto, dotati di membrana impermeabile e membrana termica, con protezioni rigide sulle nocche e cuscinetto in schiuma poliuretanicca sul palmo. Logo Moto Guzzi ricamato e applicato su patch in gomma.

Textile 6 leather gloves with waterproof membrane and thermal lining. PU knuckle protectors and foam cushion on palm. Embroidered Moto Guzzi Logo applied on a rubber patch.

NERO/BLACK

S	887104
M	887105
L	887106
XL	887107
XXL	887108

**POLO CLASSIC
UOMO / MAN**

Polo uomo in piquet di cotone.
Logo MOTO GUZZI ricamato tono su tono sul petto lato cuore.
Patch Motore applicata sulla manica.
Dettaglio su colletto e bordo manica con riga Rosso Guzzi smacchinata in rettilineo.
Etichetta tricolore sull'interno collo.

*POLO in Piquet cotton.
MOTO GUZZI embroidered TONEonTONE Logo on chest.
Engine Patch on the sleeve.
Flat knit rib on collar & sleeves, in MOTO GUZZI red color.
Tricolor label on the inside of collar edge.*

NERO/BLACK

S	606486M01B
M	606486M02B
L	606486M03B
XL	606486M04B
XXL	606486M05B
XXL	606486M06B

**T-SHIRT CLASSIC
UOMO / MAN**

T- shirt uomo in Jersey 30/1 di cotone pettinato
Stampa flat ad acqua.
Etichetta bandiera italiana all'interno del capo.
Stampa retro logo Moto Guzzi.

*Man combed cotton jersey 30/1 t-shirt.
Water print Graphics.
Italian flag label inside the garment.
Moto Guzzi logo print on the back.*

NERO/BLACK

S	606482M01B
M	606482M02B
L	606482M03B
XL	606482M04B
XXL	606482M05B
XXL	606482M06B

T-SHIRT GARAGE
 UOMO / MAN

T-shirt uomo in Jersey 30/1 di cotone pettinato. Patch ricamato applicato direttamente tramite ricamo outline. Etichetta bandiera italiana all'interno del capo. Impunture in Rosso Guzzi sulle spalle e sul retro del collo. Stampa flat ad acqua, dettagli di stampa high density a rilievo.

Man combed cotton jersey 30/1 t-shirt. Embroidered patch applied directly using outline embroidery. Italian flag label inside the garment. Guzzi Red stitching on the shoulders and back of the neck. Water print Graphics, high density printing details in relief.

GRIGIO/GREY

S	606478M01G
M	606478M02G
L	606478M03G
XL	606478M04G
XXL	606478M05G
XXL	606478M06G

T-SHIRT GARAGE
 UOMO / MAN

T-shirt uomo in Jersey 30/1 di cotone pettinato. Etichetta bandiera italiana all'interno del capo. Stampa flat ad acqua. *Man combed cotton jersey 30/1 t-shirt. Italian flag label inside the garment. Water print Graphics.*

ROSSO/RED

S	606478M01R
M	606478M02R
L	606478M03R
XL	606478M04R
XXL	606478M05R
XXL	606478M06R

T-SHIRT CLASSIC
 UOMO / MAN

T-shirt uomo in Jersey 30/1 di cotone pettinato. Etichetta bandiera italiana all'interno del capo. Stampa flat ad acqua. *Man combed cotton jersey 30/1 t-shirt. Italian flag label inside the garment. Water print Graphics.*

BIANCO/WHITE

S	606482M01W
M	606482M02W
L	606482M03W
XL	606482M04W
XXL	606482M05W
XXL	606482M06W

T-SHIRT MY BIKE MY PRIDE
 UOMO / MAN

T-shirt uomo in 100% cotone. Stampa fronte in rilievo gommata. Stampa retro logo Moto Guzzi.

Man 100% cotton t-shirt. Relief printing on the front. Moto Guzzi logo print on the back.

VERDE/GREEN

S	606033M02V
M	606033M03V
L	606033M04V
XL	606033M05V
XXL	606033M06V

NERO/BLACK

S	606033M02N
M	606033M03N
L	606033M04N
XL	606033M05N
XXL	606033M06N

BLU/BLUE

S	606033M02B
M	606033M03B
L	606033M04B
XL	606033M05B
XXL	606033M06B

T-SHIRT 19 21
 UOMO / MAN

T-shirt uomo in 100% cotone. Stampa con colore ad acqua sul fronte. Logo Moto Guzzi sul retro.

Man 100% cotton t-shirt. Color printing with water on front. Moto Guzzi logo print on the back.

GRIGIO/GREY

S	606036M02G
M	606036M03G
L	606036M04G
XL	606036M05G
XXL	606036M06G

T-SHIRT MOTO GUZZI
UOMO / MAN

T-shirt uomo in 100% cotone.
Stampa fronte logo Moto Guzzi con
colore ad acqua.

Man 100% cotton t-shirt.
Moto Guzzi logo print on front with
color water.



NERO/BLACK
.....

S	606037M02N
M	606037M03N
L	606037M04N
XL	606037M05N
XXL	606037M06N

VERDE/GREEN
.....

S	606037M02V
M	606037M03V
L	606037M04V
XL	606037M05V
XXL	606037M06V

T-SHIRT CLASSIC
DONNA / WOMAN

T-shirt donna in Jersey 30/1 di cotone pettinato
Stampa flat ad acqua.
Etichetta bandiera italiana all'interno del capo.
Stampa retro logo Moto Guzzi.

Woman combed cotton jersey 30/1 t-shirt.
Water print Graphics.
Italian flag label inside the garment.
Moto Guzzi logo print on the back.



NERO/BLACK
.....

S	606485M01B
M	606485M02B
L	606485M03B
XL	606485M04B
XXL	606485M05B
XXL	606485M06B

T-SHIRT SERAFINO
UOMO / MAN

T-shirt uomo in 100% cotone.
Stampa con colore ad acqua.
Fronte logo Moto Guzzi.
Disegno moto sul retro.

Man 100% cotton t-shirt.
Color printing with water.
Moto Guzzi logo print on front.
Bike design on the back.



GRIGIO/GREY
.....

S	606038M02G
M	606038M03G
L	606038M04G
XL	606038M05G
XXL	606038M06G

NERO/BLACK
.....

S	606038M02N
M	606038M03N
L	606038M04N
XL	606038M05N
XXL	606038M06N

T-SHIRT MY BIKE MY PRIDE
DONNA / WOMAN

T-shirt donna in 100% cotone.
Stampa fronte in rilievo gommata.
Stampa retro logo Moto Guzzi.

Woman 100% cotton t-shirt.
Relief printing on the front.
Moto Guzzi logo print on the back.



NERO/BLACK
.....

S	606041M02N
M	606041M03N
L	606041M04N
XL	606041M05N

VERDE/GREEN
.....

S	606041M02V
M	606041M03V
L	606041M04V
XL	606041M05V

BLU/BLUE
.....

S	606041M02B
M	606041M03B
L	606041M04B
XL	606041M05B

**CANOTTA MOTO GUZZI
TANK TOP MOTO GUZZI**
DONNA / WOMAN

Canotta donna in 100% cotone.
Logo Moto Guzzi sul fronte
stampato ad acqua.

*Woman 100% cotton tank top.
Moto Guzzi logo print on front
with color water.*



NERO/BLACK
.....

S	606042M02N
M	606042M03N
L	606042M04N
XL	606042M05N



VERDE/GREEN
.....

S	606042M02V
M	606042M03V
L	606042M04V
XL	606042M05V

**FELPA CLASSIC
TECH FLEECE CLASSIC**
UOMO / MAN

Tessuto accoppiato poliestere tecnico e jersey
di cotone, interno con fodera rossa.
Logo Moto Guzzi ricamato sul petto.
Stampa serigrafica ad acqua Moto Guzzi nella
parte posteriore.
Tasche esterne costruite a filetto con zip e
loop con bottone a pressione.

*Laminated jersey cotton & Polyester fabric
with red internal lining.
Embroidered Moto Guzzi logo on chest.
Moto Guzzi Graphic water print on the back.
Zip pockets with snap bottom flap.*



NERO/BLACK
.....

S	606483M01B
M	606483M02B
L	606483M03B
XL	606483M04B
XXL	606483M05B
XXL	606483M06B

**FELPA CUSTOM PUZZLE
SWEATSHIRT CUSTOM PUZZLE**
UOMO / MAN

Felpa uomo maniche raglan in 100% cotone.
Stampa fronte disegno con colore ad acqua.
Logo Moto Guzzi sul retro.

*Man 100% cotton sweatshirt.
Color printing with water on front.
Moto Guzzi logo print on the back.*



NERO/BLACK
.....

S	606039M02N
M	606039M03N
L	606039M04N
XL	606039M05N
XXL	606039M06N

**FELPA MY BIKE MY PRIDE
SWEATSHIRT MY BIKE MY PRIDE**
UOMO / MAN

Felpa uomo maniche raglan in 100% cotone.
Stampa fronte disegno con colore ad acqua.
Logo Moto Guzzi sul retro.

*Man 100% cotton sweatshirt.
Color printing with water on front.
Moto Guzzi logo print on the back.*



VERDE/GREEN
.....

S	606039M02V
M	606039M03V
L	606039M04V
XL	606039M05V
XXL	606039M06V

**FELPA GARAGE
HOODY GARAGE**
UOMO / MAN

Felpa uomo in 100% cotone.
Dettaglio cuciture a zig zag Rosso Guzzi su polsini e cappuccio
Interno non garzato per adattarsi alle diverse stagioni.

*Man 100% cotton hoody.
Zigzag stitching detail in Guzzi red on cuffs and hood
Not brushed inner lining for a 4 seasons use*



GRIGIO/GREY
.....

S	606479M01G
M	606479M02G
L	606479M03G
XL	606479M04G
XXL	606479M05G
XXL	606479M06G

**FELPA CUSTOM PUZZLE
SWEATSHIRT CUSTOM PUZZLE
UOMO / MAN**

Felpa uomo in 100% cotone.
Logo Moto Guzzi sul fronte.
Stampa moto sul retro.

*Man 100% cotton sweatshirt.
Moto Guzzi logo on front.
Bike desing print on the back.*

GRIGIO/GREY

S	606040M02G
M	606040M03G
L	606040M04G
XL	606040M05G
XXL	606040M06G

**T-SHIRT KID GARAGE
BIMBO/ KID**

T- shirt kids in 100% cotone.
Stampa flat ad acqua.

*Kids 100% cotton t-shirt.
Water print Graphics.*

GRIGIO/GREY

5/6 ANNI AGE 4/6	606481M01G
7/8 ANNI AGE 6/8	606481M01G
9/10 ANNI AGE 8/10	606481M01G

**FELPA CUSTOM PUZZLE
SWEATSHIRT CUSTOM PUZZLE
DONNA/ WOMAN**

Felpa donna in 100% cotone.
Stampa con colore ad acqua.
Fronte logo Moto Guzzi.
Disegno moto sul retro.

*Woman 100% cotton sweatshirt.
Moto Guzzi logo on front.
Bike desing print on the back.*

GRIGIO/GREY

S	606043M02G
M	606043M03G
L	606043M04G
XL	606043M05G

**FELPA MY BIKE MY PRIDE
SWEATSHIRT MY BIKE MY PRIDE
DONNA/ WOMAN**

Felpa donna in 100% cotone.
Stampa con colore ad acqua.
Fronte logo Moto Guzzi.
Disegno moto sul retro.

*Woman 100% cotton sweatshirt.
Moto Guzzi logo on front.
Bike desing print on the back.*

ROSSO/RED

S	606043M02R
M	606043M03R
L	606043M04R
XL	606043M05R

**T-SHIRT KID MOTO GUZZI
BIMBO/ KID**

T- shirt kids in 100% cotone.
Stampa logo Moto Guzzi sul fronte.
*Kids 100% cotton t-shirt.
Moto Guzzi logo print on the front.*

NERO/BLACK

4/6 ANNI AGE 4/6	606238M01N
6/8 ANNI AGE 6/8	606238M02N
8/10 ANNI AGE 8/10	606238M03N
10/12 ANNI AGE 10/12	606238M04N

**FELPA MY BIKE MY PRIDE
SWEATSHIRT MY BIKE MY PRIDE
BIMBO/ KID**

Felpa kids con cappuccio 100% cotone.
Stampa moto gommata sul fronte
*Kids 100% cotton hooded sweatshirt.
Relief bike printing on the front.*

GRIGIO/GREY

6/8 ANNI AGE 6/8	606237M01G
8/10 ANNI AGE 8/10	606237M02G
10/12 ANNI AGE 10/12	606237M03G

**BORSA DRY
DRY BAG**



Borsa in tessuto antiacqua con cuciture nastrate e chiusura a ripiegamento con fibbie. Dotata di comodi spallacci imbottiti e maniglie sia sul lato lungo che corto, è ideale per i grandi viaggi. Logo Moto Guzzi serigrafato.

Waterproof fabric bag with sealed stitching and banding closure system with straps. Padded shoulder belts and easy to use hand straps on both long & wide side can help bring with you what You need on long trips. Moto Guzzi logo printed on front side.



COD. 606523M

**ZAINO
BACKPACK**

Zaino Monospalla in canvas lavato, con inserti in pelle e minuterie in Nickel invecchiato. Accompanya i vostri spostamenti in maniera pratica e con l'inconfondibile stile Moto Guzzi.

Single shoulder strap backpack in washed Canvas & leather with small details in aged Nickel, is the most versatile solution to carry on what you need with the unmistakable Moto Guzzi style.



COD. 606376M

**BORSA TRACOLLA
SHOULDER BELT BAG**



In Canvas lavato con inserti in pelle e minuterie in Nickel invecchiato. È la compagna di viaggio ideale per le uscite con la vostra Moto Guzzi.

In washed Canvas & leather with small details in aged Nickel, this bag is the perfect luggage for small trips with your Moto Guzzi.



COD. 606380M



**CAPPELLO CLASSIC
HAT CLASSIC**

Cappellino da baseball a sei pannelli con visiera sandwich con piping bianco. Logo Engine ricamato ed Etichetta Moto Guzzi sul bordo destro.

6 panels hat with sandwich visor and white piping. Engine Logo embroidered on the left side and Moto Guzzi label on the left edge.



COD. 606484M



**CAPPELLO
HAT**

Il cappellino in Cotton Twill, con patch a filo ed etichetta Moto Guzzi in alta definizione, unisce eleganza e qualità dei materiali all'orgoglio dello stile italiano Moto Guzzi.

100% cotton twill hat, with all-thread patch & embroidered Moto Guzzi logo, perfectly match elegance and top quality of fabric with the proud Moto Guzzi style.



BAMBINO/KID
.....
COD. 606373M

UOMO/MAN
.....
COD. 606372M

**CRONOGRAFO MGX-21
MGX-210 CHRONOGRAPH**



Cronografo quarzo Swiss made, water resistant 5 ATM. Cassa acciaio inox con diametro 44mm con pulsanti e corona con galvanica nera, vetro minerale incurvato. Quadrante nero con stampa logo in colore bianco e dettagli in rosso Guzzi. Movimento a vista, incisione al laser logo MG21 su vetro posteriore. Cinturino made in Italy in pelle nera opaca con impunture rosse.

Quartz chronograph Swiss made, water resistant 5 ATM. Case in stainless steel with 44mm diameter and bezel with black galvanic. Mineral curved glass. Black dial with logo printed in white and details in Guzzi signature red. Logo MGX21 engraved on the back glass. Made in Italy strap in matt black leather with red stitching.



COD. 606493M

**TAZZA METALLO
METAL MUG**

Originale tazza in acciaio Inox 18/8 con manico a moschettone, fa parte degli oggetti indispensabili da portare in viaggio con voi e la vostra Moto Guzzi.

The unique Inox steel 18/8 mug with a carabiner handle grip, is an essential tool to bring with you during a trip on your Moto Guzzi.



NERO/BLACK
.....
COD. 606500M

ALLUMINIO/ALLUMINIUM
.....
COD. 606371M

**BORRACCIA
WATER BOTTLE**

Originale borraccia in acciaio Inox 18/8 con manico a moschettone, fa parte degli oggetti indispensabili da portare in viaggio con voi e la vostra Moto Guzzi.

The unique Inox steel 18/8 water bottle with a carabiner handle grip, is an essential tool to bring with you during a trip on your Moto Guzzi.



NERO/BLACK
.....
COD. 606501M

**PORTAFOGLIO
WALLET**

Portafoglio in vera pelle con logo Moto Guzzi in rilievo, per portare con te lo stile Moto Guzzi nella vita quotidiana.
Genuine full grain leather wallet with Moto Guzzi embossed Logo, to show the inimitable Moto Guzzi style during everyday life.

COD. 606374M
**PORTACHIAVI
KEYRINGS**

Portachiavi in vera pelle con finitura borchata e logo in rilievo. Porta sempre con te le inconfondibili sensazioni che ti regala la tua Moto Guzzi.
Genuine full grain leather with studs finishing and embossed logo. Bring the Moto Guzzi sensations with You everyday.

COD. 606375M
**CINTURE MOTO GUZZI
MOTO GUZZI BELTS**

MARRONE/BROWN
.....
COD. 605862MOBO

Cintura Moto Guzzi con fibbia ovale smaltata azzurra.
Moto Guzzi belt with light blue oval anameled buckle.

MARRONE/BROWN
.....
COD. 605922MBN

Cintura Moto Guzzi con fibbia ovale smaltata nera.
Moto Guzzi belt with black oval anameled buckle.

NERO/BLACK
.....
COD. 605862M0FI

Cintura Moto Guzzi classica.
Moto Guzzi classic belt with embossed logo.

BANDANA

Bandana unisex 100% cotone
Bandana unisex 100% cotton.

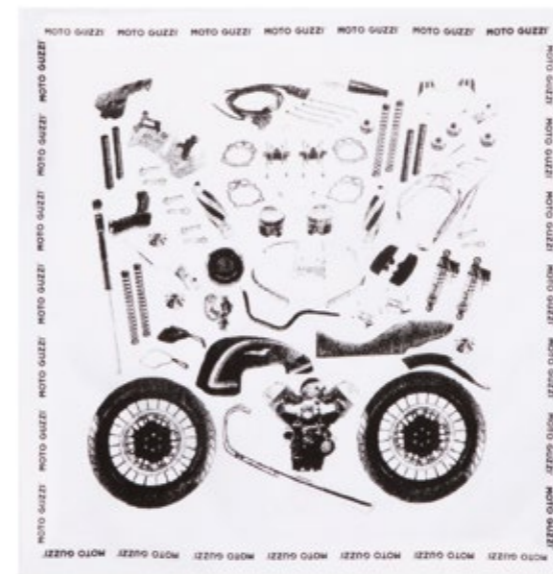
BIANCO/WHITE
.....
COD. 606046M00W

NERO/BLACK
.....
COD. 606046M00B
**SCALDACOLLO
TOURLENECK**

Scaldacollo unisex 100% cotone. Stampa con colore ad acqua. In versione semplice o micropile.
Turtleneck unisex 100% cotton. Print with color water. Micropile and basic version.

**SCALDACOLLO MICROPILE GRIGIO
TOURLENECK MICROPILE GREY**
.....
COD. 606044M00G

**SCALDACOLLO MICROPILE NERO
TOURLENECK MICROPILE BLACK**
.....
COD. 606044M00N

**SCALDACOLLO GRIGIO
NECK WARMER GREY**
.....
COD. 606045M00G

**SCALDACOLLO NERO
NECK WARMER BLACK**
.....
COD. 606045M00N

T-SHIRT THE CLAN

UOMO / MAN

T-shirt 100% cotone
Stampa Fronte Moto Guzzi «the clan»
Stampa retro Moto Guzzi

100% cotton T-shirt
Moto Guzzi «the clan» print on the front
Moto Guzzi print on the back



NERO/BLACK

S	606049M022
M	606049M032
L	606049M042
XL	606049M052
XXL	606049M062

NERO/BLACK

M	606011M032
L	606011M042
XL	606011M052
XXL	606011M062

T-SHIRT THE CLAN

DONNA/ WOMAN

T-shirt 100% cotone
Stampa Fronte Moto Guzzi «the clan»
Stampa retro Moto Guzzi

100% cotton T-shirt
Moto Guzzi «the clan» print on the front
Moto Guzzi print on the back



NERO/BLACK

XS	606050M012
S	606050M022
M	606050M032
L	606050M042
XL	606050M052

NERO/BLACK

S	606012M022
M	606012M032
L	606012M042
XL	606012M052

CASCO THE CLAN THE CLAN HELMET



XS	606361M01C
S	606361M02C
M	606361M03C
L	606361M04C
XL	606361M05C

CAPPELLO BASEBALL BASEBALL CAP

100% cotone
Logo Moto Guzzi ricamato

100% cotton
Embroidered Moto Guzzi Logo



COD. 606010M

PATCH THE CLAN



COD. 606013M002



COD. 606013M001





Le descrizioni dei prodotti e degli accessori presenti in questo catalogo (dimensioni, misure, specifiche) sono basate su informazioni disponibili al momento della pubblicazione.

Moto Guzzi[®] si riserva il diritto di effettuare in qualsiasi momento modifiche alle descrizioni e alle specifiche o di cambiare o mettere in discontinuità qualsiasi oggetto presente in questo catalogo senza alcun obbligo di comunicazione e senza incorrere in alcuna obbligazione.

Per maggiori informazioni sulle caratteristiche e sulla disponibilità dei singoli accessori rivolgetevi alla rete di vendita Moto Guzzi[®].

Moto Guzzi[®] è un marchio di titolarità esclusiva di Piaggio & C. spa. Tutti i diritti riservati.

All products and accessories description (measurement, dimensions, specifications) are based on available information at the time of publication. Moto Guzzi[®] may make changes at any time to specifications and description and may change or discontinue any of the items included in this catalogue, without notice and without incurring any obligations.

For other information on technical characteristics and availability of single accessories please refer to Moto Guzzi[®] dealer network. Moto Guzzi[®] is a Piaggio & C spa. brand. All rights reserved.



MOTO GUZZI®

MOTOGUZZI.COM